



 Read this manual carefully before operating this vehicle.

OWNER'S MANUAL

TMAX

XP500
XP500A

4B5-28199-E2

 **Read this manual carefully before operating this vehicle. This manual should stay with this vehicle if it is sold.**



YAMAHA MOTOR ELECTRONICS CO., LTD.
1450-6, Mori, Mori-machi, Shuchi-gun, Shizuoka-ken, 437-0292 Japan

DECLARATION of CONFORMITY

We

Company: YAMAHA MOTOR ELECTRONICS CO., LTD.

Address: 1450-6, Mori, Mori-Machi, Shuchi-gun, Shizuoka-Ken, 437-0292 Japan

Hereby declare that the product:

Kind of equipment: IMMOBILIZER

Type-designation: SSL-00

is in compliance with following norm(s) or documents:

R&TTE Directive(1999/5/EC)

EN300 330-2 v1.1.1(2001-6), EN60950-1(2001)

Two or Three-Wheel Motor Vehicles Directive(97/24/EC: Chapter 8, EMC)

Place of issue: Shizuoka, Japan

Date of issue: 1 Aug. 2002

Revision record

No.	Contents	Date
1	To change contact person and integrate type-designation.	9 Jun. 2005
2	Version up the norm of EN60950 to EN60950-1	27 Feb. 2006
3	To change company name	1 Mar. 2007

General manager of quality assurance div.

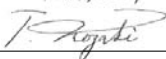
01/Mar/2007

Welcome to the Yamaha world of motorcycling!

As the owner of the XP500/XP500A, you are benefiting from Yamaha's vast experience and newest technology regarding the design and manufacture of high-quality products, which have earned Yamaha a reputation for dependability.

Please take the time to read this manual thoroughly, so as to enjoy all advantages of your XP500/XP500A. The Owner's Manual does not only instruct you in how to operate, inspect and maintain your scooter, but also in how to safeguard yourself and others from trouble and injury.

In addition, the many tips given in this manual will help keep your scooter in the best possible condition. If you have any further questions, do not hesitate to contact your Yamaha dealer.

The Yamaha team wishes you many safe and pleasant rides. So, remember to put safety first!

Yamaha continually seeks advancements in product design and quality. Therefore, while this manual contains the most current product information available at the time of printing, there may be minor discrepancies between your motorcycle and this manual. If there is any question concerning this manual, please consult a Yamaha dealer.





Please read this manual carefully and completely before operating this scooter.

IMPORTANT MANUAL INFORMATION

EAU10132

Particularly important information is distinguished in this manual by the following notations:

	This is the safety alert symbol. It is used to alert you to potential personal injury hazards. Obey all safety messages that follow this symbol to avoid possible injury or death.
	A WARNING indicates a hazardous situation which, if not avoided, could result in death or serious injury.
	A NOTICE indicates special precautions that must be taken to avoid damage to the vehicle or other property.
TIP	A TIP provides key information to make procedures easier or clearer.

IMPORTANT MANUAL INFORMATION

EAU10200

**XP500/XP500A
OWNER'S MANUAL
©2008 by Yamaha Motor Co., Ltd.
1st edition, June 2008
All rights reserved.
Any reprinting or unauthorized use
without the written permission of
Yamaha Motor Co., Ltd.
is expressly prohibited.
Printed in Japan.**

TABLE OF CONTENTS

SAFETY INFORMATION	1-1	Shock absorber assembly	3-22	Checking the throttle cable free	
Further safe-riding points	1-5	Sidestand	3-23	play	6-18
DESCRIPTION	2-1	Ignition circuit cut-off system	3-23	Valve clearance	6-18
Left view	2-1	FOR YOUR SAFETY –		Tires	6-19
Right view	2-2	PRE-OPERATION CHECKS	4-1	Cast wheels	6-20
Controls and instruments.....	2-3	OPERATION AND IMPORTANT		Front and rear brake lever free	
INSTRUMENT AND CONTROL		RIDING POINTS	5-1	play	6-21
FUNCTIONS	3-1	Starting the engine	5-1	Adjusting the rear brake lock lever	
Immobilizer system	3-1	Starting off	5-2	cable	6-21
Main switch/steering lock	3-2	Acceleration and deceleration	5-2	Checking the front and rear brake	
Indicator and warning lights	3-3	Braking	5-3	pads	6-22
Speedometer	3-4	Tips for reducing fuel		Checking the brake fluid level	6-23
Fuel gauge	3-5	consumption	5-3	Changing the brake fluid	6-24
Coolant temperature gauge	3-5	Engine break-in	5-4	Checking and lubricating the throttle	
Multi-function display	3-6	Parking	5-4	grip and cable	6-24
Anti-theft alarm (optional)	3-11	PERIODIC MAINTENANCE AND		Lubricating the front and rear brake	
Handlebar switches	3-11	ADJUSTMENT	6-1	levers	6-25
Front brake lever	3-12	Owner's tool kit	6-2	Checking and lubricating the	
Rear brake lever	3-13	Periodic maintenance and lubrication		centerstand and sidestand	6-25
Rear brake lock lever	3-14	chart	6-3	Checking the front fork	6-26
ABS (for ABS models)	3-14	Removing and installing panels	6-7	Checking the steering	6-27
Fuel tank cap	3-15	Checking the spark plugs	6-10	Checking the wheel bearings	6-27
Fuel	3-16	Engine oil and oil filter cartridge	6-11	Battery	6-27
Catalytic converter	3-18	Chain drive oil	6-14	Replacing the fuses	6-29
Seat	3-18	Coolant	6-15	Replacing the headlight bulb	6-31
Adjusting the rider backrest	3-19	Replacing the air filter element	6-17	Tail/brake light	6-32
Helmet holder	3-20	Adjusting the engine idling		Replacing a front turn signal light	
Storage compartments	3-20	speed	6-17	bulb	6-32
Rear view mirrors	3-22			Rear turn signal light bulb	6-33
				Replacing the license plate light	
				bulb	6-33

TABLE OF CONTENTS

Replacing an auxiliary light bulb	6-34
Troubleshooting	6-34
Troubleshooting charts	6-35

SCOOTER CARE AND

STORAGE	7-1
Matte color caution	7-1
Care	7-1
Storage	7-3

SPECIFICATIONS	8-1
-----------------------------	-----

CONSUMER INFORMATION	9-1
Identification numbers	9-1

SAFETY INFORMATION

EAU10263

Be a Responsible Owner

As the vehicle's owner, you are responsible for the safe and proper operation of your scooter.

Scooters are single-track vehicles.

Their safe use and operation are dependent upon the use of proper riding techniques as well as the expertise of the operator. Every operator should know the following requirements before riding this scooter.

He or she should:

- Obtain thorough instructions from a competent source on all aspects of scooter operation.
- Observe the warnings and maintenance requirements in this Owner's Manual.
- Obtain qualified training in safe and proper riding techniques.
- Obtain professional technical service as indicated in this Owner's Manual and/or when made necessary by mechanical conditions.

Safe Riding

Perform the pre-operation checks each

time you use the vehicle to make sure it is in safe operating condition. Failure to inspect or maintain the vehicle properly increases the possibility of an accident or equipment damage. See page 4-1 for a list of pre-operation checks.

- This scooter is designed to carry the operator and a passenger.
- The failure of motorists to detect and recognize scooters in traffic is the predominating cause of automobile/scooter accidents. Many accidents have been caused by an automobile driver who did not see the scooter. Making yourself conspicuous appears to be very effective in reducing the chance of this type of accident.

Therefore:

- Wear a brightly colored jacket.
- Use extra caution when you are approaching and passing through intersections, since intersections are the most likely places for scooter accidents to occur.
- Ride where other motorists can see you. Avoid riding in another

motorist's blind spot.

- Many accidents involve inexperienced operators. In fact, many operators who have been involved in accidents do not even have a current driver's license.
- Make sure that you are qualified and that you only lend your scooter to other qualified operators.
- Know your skills and limits. Staying within your limits may help you to avoid an accident.
- We recommend that you practice riding your scooter where there is no traffic until you have become thoroughly familiar with the scooter and all of its controls.
- Many accidents have been caused by error of the scooter operator. A typical error made by the operator is veering wide on a turn due to excessive speed or undercornering (insufficient lean angle for the speed).
- Always obey the speed limit and never travel faster than warrant-

- ed by road and traffic conditions.
- Always signal before turning or changing lanes. Make sure that other motorists can see you.
 - The posture of the operator and passenger is important for proper control.
 - The operator should keep both hands on the handlebar and both feet on the operator footrests during operation to maintain control of the scooter.
 - The passenger should always hold onto the operator, the seat strap or grab bar, if equipped, with both hands and keep both feet on the passenger footrests. Never carry a passenger unless he or she can firmly place both feet on the passenger footrests.
 - Never ride under the influence of alcohol or other drugs.
 - This scooter is designed for on-road use only. It is not suitable for off-road use.

Protective apparel

The majority of fatalities from scooter

accidents are the result of head injuries. The use of a safety helmet is the single most critical factor in the prevention or reduction of head injuries.

- Always wear an approved helmet.
- Wear a face shield or goggles. Wind in your unprotected eyes could contribute to an impairment of vision that could delay seeing a hazard.
- The use of a jacket, substantial shoes, trousers, gloves, etc., is effective in preventing or reducing abrasions or lacerations.
- Never wear loose-fitting clothes, otherwise they could catch on the control levers or wheels and cause injury or an accident.
- Always wear protective clothing that covers your legs, ankles, and feet. The engine or exhaust system become very hot during or after operation and can cause burns.
- A passenger should also observe the above precautions.

Avoid Carbon Monoxide Poisoning

All engine exhaust contains carbon

monoxide, a deadly gas. Breathing carbon monoxide can cause headaches, dizziness, drowsiness, nausea, confusion, and eventually death.

Carbon Monoxide is a colorless, odorless, tasteless gas which may be present even if you do not see or smell any engine exhaust. Deadly levels of carbon monoxide can collect rapidly and you can quickly be overcome and unable to save yourself. Also, deadly levels of carbon monoxide can linger for hours or days in enclosed or poorly ventilated areas. If you experience any symptoms of carbon monoxide poisoning, leave the area immediately, get fresh air, and **SEEK MEDICAL TREATMENT.**

- Do not run engine indoors. Even if you try to ventilate engine exhaust with fans or open windows and doors, carbon monoxide can rapidly reach dangerous levels.
- Do not run engine in poorly ventilated or partially enclosed areas such as barns, garages, or carports.
- Do not run engine outdoors where

SAFETY INFORMATION

engine exhaust can be drawn into a building through openings such as windows and doors.

1

Loading

Adding accessories or cargo to your scooter can adversely affect stability and handling if the weight distribution of the scooter is changed. To avoid the possibility of an accident, use extreme caution when adding cargo or accessories to your scooter. Use extra care when riding a scooter that has added cargo or accessories. Here, along with the information about accessories below, are some general guidelines to follow if loading cargo to your scooter:

The total weight of the operator, passenger, accessories and cargo must not exceed the maximum load limit.

Operation of an overloaded vehicle could cause an accident.

Maximum load:

XP500 194 kg (428 lb)

XP500A 190 kg (419 lb)

When loading within this weight limit, keep the following in mind:

- Cargo and accessory weight should be kept as low and close to the scooter as possible. Securely pack your heaviest items as close to the center of the vehicle as possible and make sure to distribute the weight as evenly as possible on both sides of the scooter to minimize imbalance or instability.
- Shifting weights can create a sudden imbalance. Make sure that accessories and cargo are securely attached to the scooter before riding. Check accessory mounts and cargo restraints frequently.
 - Properly adjust the suspension for your load (suspension-adjustable models only), and check the condition and pressure of your tires.
 - Never attach any large or heavy items to the handlebar, front fork, or front fender. Such items can create unstable handling or a slow steering response.
- **This vehicle is not designed to pull a trailer or to be attached to a sidecar.**

Genuine Yamaha Accessories

Choosing accessories for your vehicle is an important decision. Genuine Yamaha accessories, which are available only from a Yamaha dealer, have been designed, tested, and approved by Yamaha for use on your vehicle.

Many companies with no connection to Yamaha manufacture parts and accessories or offer other modifications for Yamaha vehicles. Yamaha is not in a position to test the products that these aftermarket companies produce. Therefore, Yamaha can neither endorse nor recommend the use of accessories not sold by Yamaha or modifications not specifically recommended by Yamaha, even if sold and installed by a Yamaha dealer.

Aftermarket Parts, Accessories, and Modifications

While you may find aftermarket products similar in design and quality to genuine Yamaha accessories, recognize that some aftermarket accessories or modifications are not suitable because of potential safety hazards to you

or others. Installing aftermarket products or having other modifications performed to your vehicle that change any of the vehicle's design or operation characteristics can put you and others at greater risk of serious injury or death. You are responsible for injuries related to changes in the vehicle.

Keep the following guidelines in mind, as well as those provided under "Loading" when mounting accessories.

- Never install accessories or carry cargo that would impair the performance of your scooter. Carefully inspect the accessory before using it to make sure that it does not in any way reduce ground clearance or cornering clearance, limit suspension travel, steering travel or control operation, or obscure lights or reflectors.
- Accessories fitted to the handlebar or the front fork area can create instability due to improper weight distribution or aerodynamic changes. If accessories are added to the handlebar or front fork area, they must be as

lightweight as possible and should be kept to a minimum.

- Bulky or large accessories may seriously affect the stability of the scooter due to aerodynamic effects. Wind may attempt to lift the scooter, or the scooter may become unstable in cross winds. These accessories may also cause instability when passing or being passed by large vehicles.
- Certain accessories can displace the operator from his or her normal riding position. This improper position limits the freedom of movement of the operator and may limit control ability, therefore, such accessories are not recommended.
- Use caution when adding electrical accessories. If electrical accessories exceed the capacity of the scooter's electrical system, an electric failure could result, which could cause a dangerous loss of lights or engine power.

Aftermarket Tires and Rims

The tires and rims that came with your scooter were designed to match the performance capabilities and to provide the best combination of handling, braking, and comfort. Other tires, rims, sizes, and combinations may not be appropriate. Refer to page 6-19 for tire specifications and more information on replacing your tires.

SAFETY INFORMATION

EAU10372

Further safe-riding points

- Be sure to signal clearly when making turns.
- Braking can be extremely difficult on a wet road. Avoid hard braking, because the scooter could slide. Apply the brakes slowly when stopping on a wet surface.
- Slow down as you approach a corner or turn. Once you have completed a turn, accelerate slowly.
- Be careful when passing parked cars. A driver might not see you and open a door in your path.
- Railroad crossings, streetcar rails, iron plates on road construction sites, and manhole covers become extremely slippery when wet. Slow down and cross them with caution. Keep the scooter upright, otherwise it could slide out from under you.
- The brake pads could get wet when you wash the scooter. After washing the scooter, check the brakes before riding.
- Always wear a helmet, gloves, trousers (tapered around the cuff and ankle so they do not flap), and a bright colored jacket.
- Do not carry too much luggage on the scooter. An overloaded scooter is unstable. Use a strong cord to secure any luggage to the carrier (if equipped). A loose load will affect the stability of the scooter and could divert your attention from the road. (See page 1-1.)

Left view

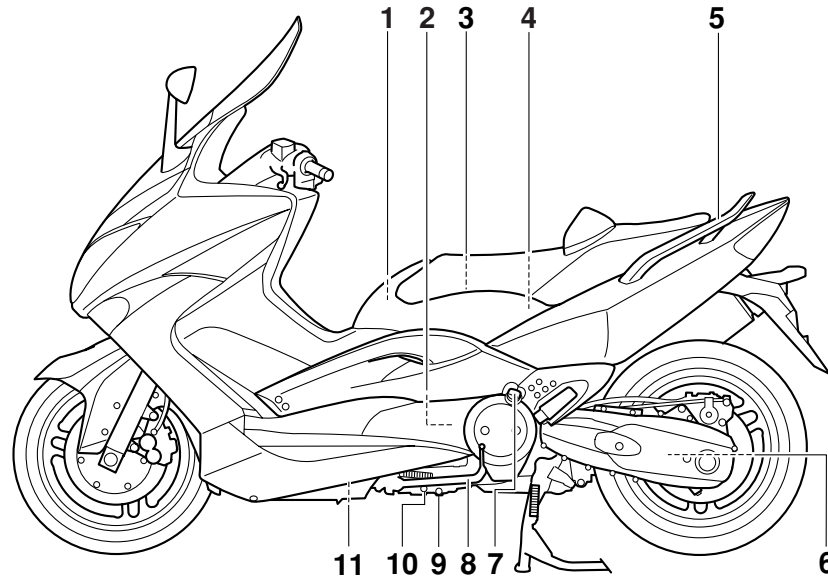

1. Fuel tank cap (page 3-15)
2. V-belt air filter element (left)
3. Helmet holder (page 3-20)
4. Rear storage compartment (page 3-20)
5. Grab bar (page 5-2)
6. Chain drive oil filler cap (page 6-14)
7. Engine oil filler cap (page 6-11)
8. Sidestand (page 3-23, 6-25)

9. Engine oil drain bolt (page 6-11)
10. Engine oil level check window (page 6-11)
11. Oil filter cartridge (page 6-11)

DESCRIPTION

EAU10420

Right view

2

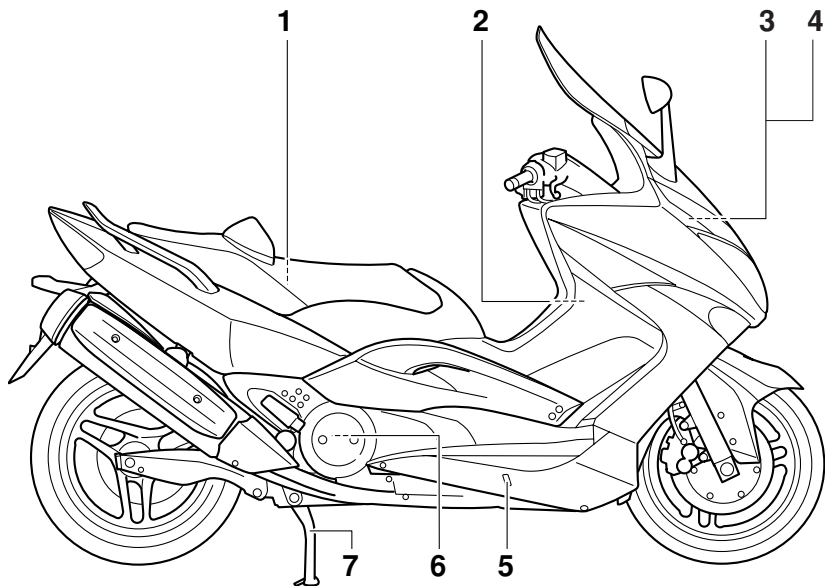

1. Owner's tool kit (page 6-2)
2. Air filter element (page 6-17)
3. Battery (page 6-27)
4. Fuses (page 6-29)
5. Coolant level check window (page 6-15)
6. V-belt air filter element (right)
7. Centerstand (page 6-25)

Controls and instruments

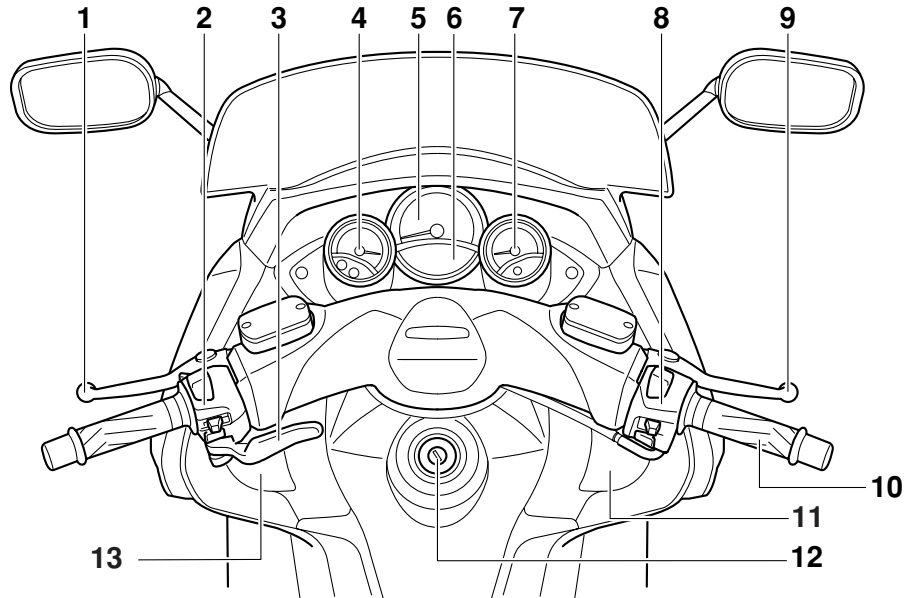

1. Rear brake lever (page 3-13)
2. Left handlebar switches (page 3-11)
3. Rear brake lock lever (page 3-14)
4. Coolant temperature gauge (page 3-5)
5. Speedometer (page 3-4)
6. Multi-function display (page 3-6)
7. Fuel gauge (page 3-5)
8. Right handlebar switches (page 3-11)

9. Front brake lever (page 3-12)
10. Throttle grip (page 6-18)
11. Front storage compartment B (page 3-20)
12. Main switch/steering lock (page 3-2)
13. Front storage compartment A (page 3-20)

INSTRUMENT AND CONTROL FUNCTIONS

Immobilizer system

EAU10974

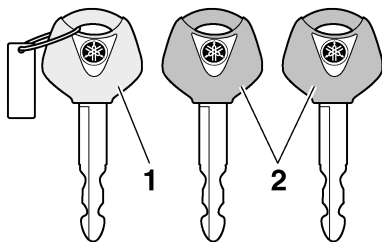

1. Code re-registering key (red bow)
2. Standard keys (black bow)

This vehicle is equipped with an immobilizer system to help prevent theft by re-registering codes in the standard keys. This system consists of the following.

- a code re-registering key (with a red bow)
- two standard keys (with a black bow) that can be re-registered with new codes
- a transponder (which is installed in the code re-registering key)
- an immobilizer unit
- an ECU (Electronic Control Unit)

- an immobilizer system indicator light (See page 3-3.)

The key with the red bow is used to register codes in each standard key. Since re-registering is a difficult process, take the vehicle along with all three keys to a Yamaha dealer to have them re-registered. Do not use the key with the red bow for driving. It should only be used for re-registering the standard keys. Always use a standard key for driving.

ECA11821

NOTICE

- **DO NOT LOSE THE CODE RE-REGISTERING KEY! CONTACT YOUR DEALER IMMEDIATELY IF IT IS LOST!** If the code re-registering key is lost, registering new codes in the standard keys is impossible. The standard keys can still be used to start the vehicle, however if code re-registering is required (i.e., if a new standard key is made or all keys are lost) the entire immobilizer system must be replaced. Therefore, it is highly recommended to use either standard key and keep the code

re-registering key in a safe place.

- Do not submerge any key in water.
- Do not expose any key to excessively high temperatures.
- Do not place any key close to magnets (this includes, but not limited to, products such as speakers, etc.).
- Do not place items that transmit electrical signals close to any key.
- Do not place heavy items on any key.
- Do not grind any key or alter its shape.
- Do not disassemble the plastic part of any key.
- Do not put two keys of any immobilizer system on the same key ring.
- Keep the standard keys as well as keys of other immobilizer systems away from this vehicle's code re-registering key.
- Keep other immobilizer system keys away from the main switch

INSTRUMENT AND CONTROL FUNCTIONS

as they may cause signal interference.

Main switch/steering lock

EAU10471



The main switch/steering lock controls the ignition and lighting systems, and is used to lock the steering.

TIP

Be sure to use the standard key (black bow) for regular use of the vehicle. To minimize the risk of losing the code re-registering key (red bow), keep it in a safe place and only use it for code re-registering.

EAU34121

ON

All electrical circuits are supplied with power; the meter lighting, taillight, license plate light and auxiliary lights

come on, and the engine can be started. The key cannot be removed.

TIP

The headlights come on automatically when the engine is started and stay on until the key is turned to “OFF” or the sidestand is moved down.

EAU10661

OFF

All electrical systems are off. The key can be removed.

EWA10061

WARNING

Never turn the key to “OFF” or “LOCK” while the vehicle is moving. Otherwise the electrical systems will be switched off, which may result in loss of control or an accident.

EAU10681

LOCK

The steering is locked, and all electrical systems are off. The key can be removed.

To lock the steering

1. Turn the handlebars all the way to

INSTRUMENT AND CONTROL FUNCTIONS

the left.

2. Push the key in from the “OFF” position, and then turn it to “LOCK” while still pushing it.
3. Remove the key.

To unlock the steering

Push the key in, and then turn it to “OFF” while still pushing it.

3

P (Parking)

The steering is locked, and the taillight, license plate light and auxiliary lights are on. The hazard lights and turn signal lights can be turned on, but all other electrical systems are off. The key can be removed.

The steering must be locked before the key can be turned to “P”.

EAU10941

NOTICE

Do not use the parking position for an extended length of time, otherwise the battery may discharge.

ECA11020

Indicator and warning lights

EAU11003

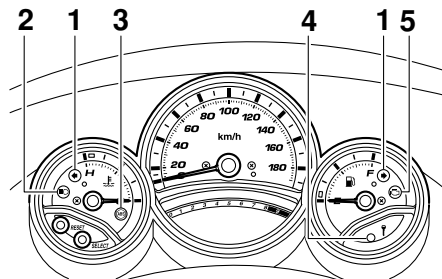

1. Turn signal indicator lights “ \leftarrow ” and “ \rightarrow ”
2. High beam indicator light “ \equiv ”
3. Anti-lock Brake System (ABS) warning light “ \odot ” (for ABS models)
4. Immobilizer system indicator light
5. Engine trouble warning light “ ⚙ ”

EAU11030

Turn signal indicator lights “ \leftarrow ” and “ \rightarrow ”

The corresponding indicator light flashes when the turn signal switch is pushed to the left or right.

EAU11080

High beam indicator light “ \equiv ”

This indicator light comes on when the

high beam of the headlight is switched on.

EAU43021

Engine trouble warning light “ ⚙ ”

This warning light comes on if an electrical circuit monitoring the engine is not working correctly. If this occurs, have a Yamaha dealer check the self-diagnosis system.

The electrical circuit of the warning light can be checked by turning the key to “ON”. If the warning light does not come on for a few seconds, then go off, have a Yamaha dealer check the electrical circuit.

TIP

This warning light will come on when the key is turned to “ON” and the start switch is pushed, but this does not indicate a malfunction.

EAU43031

ABS warning light “ \odot ” (for ABS models)

ECA10831

NOTICE

If the ABS warning light comes on or

flashes while riding, the ABS may not work correctly. If this occurs, have a Yamaha dealer check the electrical circuit.

See page 3-14 for an explanation of the ABS.

The electrical circuit of the warning light can be checked by setting the engine stop switch to “○” and turning the key to “ON”. The warning light should come on for a few seconds, and then go off. If the warning light does not come on or remains on, have a Yamaha dealer check the electrical circuit.

EWA11350

⚠ WARNING

When the ABS warning light comes on or flashes while riding, the brake system reverts to conventional braking. Therefore, be careful not to cause the wheel to lock during emergency braking.

TIP

The ABS warning light may come on while accelerating the engine with the scooter on its centerstand, but this does not indicate a malfunction.

EAU38621

Immobilizer system indicator light

The electrical circuit of the indicator light can be checked by turning the key to “ON”.

If the indicator light does not come on for a few seconds, then go off, have a Yamaha dealer check the electrical circuit.

When the key is turned to “OFF” and 30 seconds have passed, the indicator light will start flashing indicating the immobilizer system is enabled. After 24 hours have passed, the indicator light will stop flashing, however the immobilizer system is still enabled.

This model is also equipped with a self-diagnosis device for the immobilizer system. (See page 3-9 for an explanation of the self-diagnosis device.)

EAU11601

Speedometer

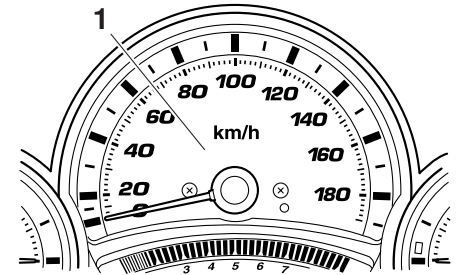

1. Speedometer

The speedometer shows the riding speed.

When the key is turned to “ON”, the speedometer needle will sweep once across the speed range and then return to zero in order to test the electrical circuit.

INSTRUMENT AND CONTROL FUNCTIONS

EAU44981

completely.

EAU12182

Fuel gauge

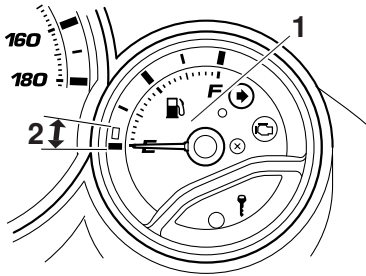

1. Fuel gauge
2. Red zone

The fuel gauge indicates the amount of fuel in the fuel tank. When the key is turned to “ON”, the fuel gauge needle will sweep once across the fuel level range and then return to “E” (Empty) in order to test the electrical circuit. The needle moves towards “E” as the fuel level decreases. When the needle reaches the red zone, approximately 3.0 L (0.79 US gal, 0.66 Imp.gal) remain in the fuel tank. If this occurs, re-fuel as soon as possible.

TIP _____
Do not allow the fuel tank to empty itself

Coolant temperature gauge

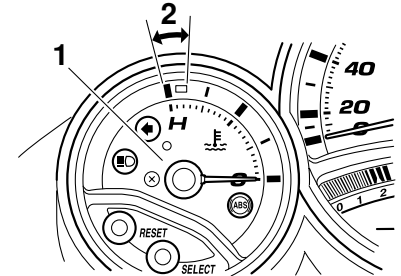

1. Coolant temperature gauge
2. Red zone

With the key in the “ON” position, the coolant temperature gauge indicates the temperature of the coolant. When the key is turned to “ON”, the coolant temperature gauge needle will sweep once across the temperature range and then return to “C” in order to test the electrical circuit. The coolant temperature varies with changes in the weather and engine load. If the needle reaches or enters the red zone, stop the vehicle and let the engine cool. (See page 6-35.)

INSTRUMENT AND CONTROL FUNCTIONS

ECA10021

EAU44966

EWA12312

NOTICE

Do not continue to operate the engine if it is overheating.

Multi-function display

WARNING

Be sure to stop the vehicle before making any setting changes to the multi-function display. Changing settings while riding can distract the operator and increase the risk of an accident.

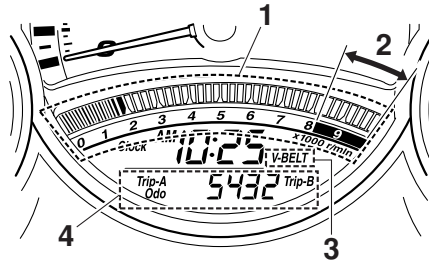

1. Tachometer
2. Tachometer red zone
3. V-belt replacement indicator "V-BELT"
4. Odometer/tripmeters

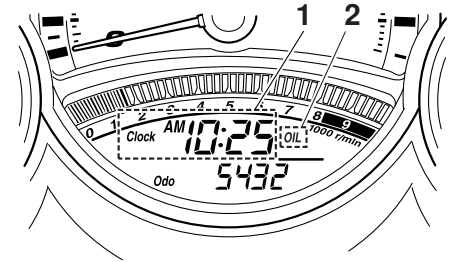

1. Clock
2. Oil change indicator "OIL"

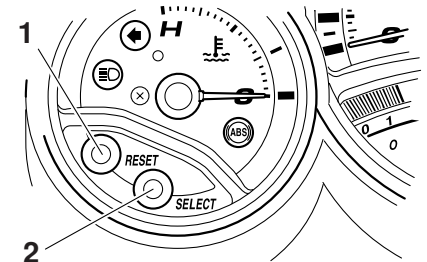

1. "RESET" button
2. "SELECT" button

The multi-function display is equipped with the following:

- a tachometer (which shows engine speed)

INSTRUMENT AND CONTROL FUNCTIONS

- an odometer (which shows the total distance traveled)
- two tripmeters (which show the distance traveled since they were last set to zero)
- a fuel reserve tripmeter (which shows the distance traveled when the remaining fuel in the fuel tank reaches approximately 3.0 L (0.79 US gal, 0.66 Imp.gal))
- a self-diagnosis device
- a clock
- an oil change tripmeter (which shows the distance traveled since the last engine oil change)
- a V-belt replacement tripmeter (which shows the distance traveled since the last V-belt replacement)

TIP

- Be sure to turn the key to “ON” before using the “SELECT” and “RESET” buttons.
- When the key is turned to “ON”, all of the display segments of the multi-function display will appear one after the other and then disappear, in order to test the electrical

circuits.

Tachometer

The tachometer allows the rider to monitor the engine speed and keep it within the ideal power range.

ECA10031

NOTICE

Do not operate the engine in the tachometer red zone.

Red zone: 8250 r/min and above

Clock

To set the clock:

1. Push the “SELECT” button and “RESET” button together for at least two seconds.
2. When the hour digits start flashing, push the “RESET” button to set the hours.
3. Push the “SELECT” button, and the minute digits will start flashing.
4. Push the “RESET” button to set the minutes.
5. Push the “SELECT” button and then release it to start the clock.

Odometer and tripmeter modes

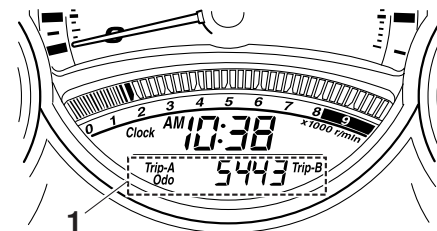

1. Odometer/tripmeters

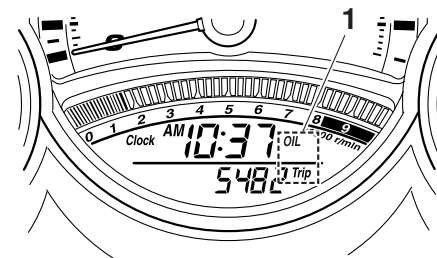

1. Oil change tripmeter

INSTRUMENT AND CONTROL FUNCTIONS

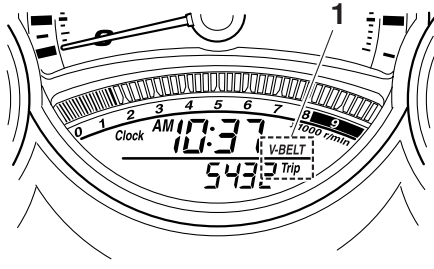

1. V-belt replacement tripmeter

Pushing the “SELECT” button switches the display between the odometer mode and the tripmeter modes in the following order:

Odo → Trip-A → Trip-B → OIL Trip → V-BELT Trip → Odo

When approximately 3.0 L (0.79 US gal, 0.66 Imp.gal) of fuel remains in the fuel tank, the display will automatically change to the fuel reserve tripmeter mode “F Trip” and start counting the distance traveled from that point. In that case, pushing the “SELECT” button switches the display between the various tripmeter and odometer modes in the following order:

Odo → F Trip → Trip-A → Trip-B → OIL

Trip → V-BELT Trip → Odo

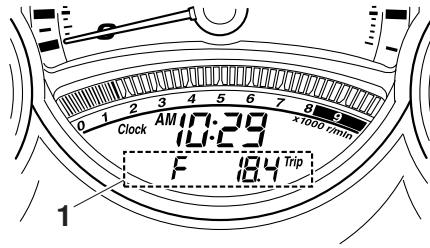

1. Fuel reserve tripmeter

To reset a tripmeter, select it by pushing the “SELECT” button until “F Trip”, “Trip-A” or “Trip-B” is displayed. While “F Trip”, “Trip-A” or “Trip-B” is displayed, push the “RESET” button for at least one second. If you do not reset the fuel reserve tripmeter manually, it will reset itself automatically and the display will return to the prior mode after refueling and traveling 5 km (3 mi).

TIP

The display cannot be changed back to “F Trip” after pushing the “RESET” button.

Oil change indicator “OIL”

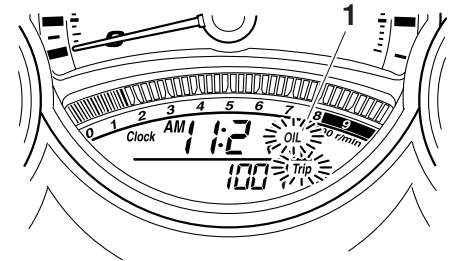

1. Oil change indicator “OIL”

This indicator flashes at the initial 1000 km (600 mi), then at 5000 km (3000 mi) and every 5000 km (3000 mi) thereafter to indicate that the engine oil should be changed.

After changing the engine oil, reset the oil change indicator. To reset the oil change indicator, select it by pushing the “SELECT” button until “OIL Trip” is displayed, and then push the “RESET” button at least 1 second. When pushing the “RESET” button, “OIL Trip” starts flashing. While “OIL Trip” is flashing, push the “RESET” button for at least 3 seconds.

If the engine oil is changed before the

INSTRUMENT AND CONTROL FUNCTIONS

oil change indicator “OIL” flashes (i.e. before the periodic oil change interval has been reached), the indicator “OIL” must be reset after the oil change for the next periodic oil change to be indicated at the correct time.

The electrical circuit of the indicator can be checked according to the following procedure.

1. Set the engine stop switch to “○” and turn the key to “ON”.
2. Check that the oil change indicator comes on for a few seconds and then goes off.
3. If the oil change indicator does not come on, have a Yamaha dealer check the electrical circuit.

V-belt replacement indicator “V-BELT”

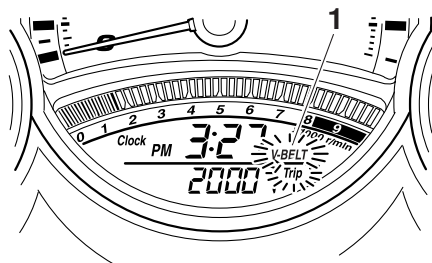

1. V-belt replacement indicator “V-BELT”

This indicator flashes every 20000 km (12500 mi) when the V-belt needs to be replaced.

After changing the V-belt, reset the V-belt replacement indicator. To reset the V-belt replacement indicator, select it by pushing the “SELECT” button until “V-BELT Trip” is displayed, and then push the “RESET” button at least 1 second. When pushing the “RESET” button, “V-BELT Trip” starts flashing. While “V-BELT Trip” is flashing, push the “RESET” button for at least 3 seconds.

If the V-belt is changed before the

V-belt replacement indicator “V-BELT” flashes (i.e. before the periodic V-belt change interval has been reached), the indicator “V-BELT” must be reset after the V-belt change for the next periodic V-belt change to be indicated at the correct time.

The electrical circuit of the indicator can be checked according to the following procedure.

1. Turn the key to “ON” and make sure that the engine stop switch is set to “○”.
2. Check that the V-belt replacement indicator comes on for a few seconds and then goes off.
3. If the V-belt replacement indicator does not come on, have a Yamaha dealer check the electrical circuit.

Self-diagnosis device

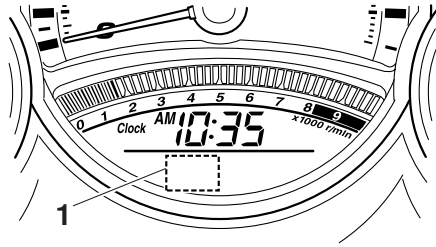

1. Error code display

This model is equipped with a self-diagnosis device for various electrical circuits.

If a problem is detected in any of those circuits, the engine trouble warning light comes on and the display indicates a two-digit error code.

This model is also equipped with a self-diagnosis device for the immobilizer system.

If a problem is detected in any of the immobilizer system circuits, the immobilizer system indicator light flashes and the display indicates a two-digit error code.

TIP

If the display indicates error code 52, this could be caused by transponder interference. If this error code appears, try the following.

1. Use the code re-registering key to start the engine.

TIP

Make sure there are no other immobilizer keys close to the main switch, and do not keep more than one immobilizer key on the same key ring! Immobilizer system keys may cause signal interference, which may prevent the engine from starting.

2. If the engine starts, turn it off and try starting the engine with the standard keys.
3. If one or both of the standard keys do not start the engine, take the vehicle, the code re-registering key and both standard keys to a Yamaha dealer and have the standard keys re-registered.

If the display indicates any error codes, note the code number, and then have a Yamaha dealer check the vehicle.

NOTICE

If the display indicates an error code, the vehicle should be checked as soon as possible in order to avoid engine damage.

INSTRUMENT AND CONTROL FUNCTIONS

Anti-theft alarm (optional)

This model can be equipped with an optional anti-theft alarm by a Yamaha dealer. Contact a Yamaha dealer for more information.

EAU12331

Handlebar switches

Left

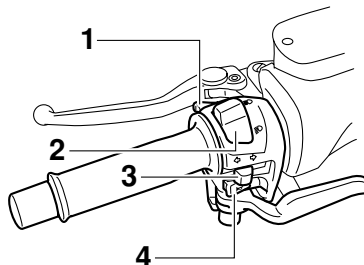

1. Pass switch "PASS"
2. Dimmer switch "≡○/≡○"
3. Turn signal switch "↔/↔"
4. Horn switch "🔊"

EAU12347

Right

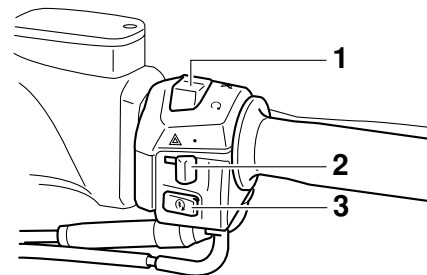

1. Engine stop switch "○/⊗"
2. Hazard switch "△"
3. Start switch "🔌"

EAU12360

Pass switch "PASS"

Press this switch to flash the headlight.

EAU12400

Dimmer switch "≡○/≡○"

Set this switch to "≡○" for the high beam and to "≡○" for the low beam.

EAU12460

Turn signal switch "↔/↔"

To signal a right-hand turn, push this switch to "↔". To signal a left-hand turn, push this switch to "↔". When re-

INSTRUMENT AND CONTROL FUNCTIONS



leased, the switch returns to the center position. To cancel the turn signal lights, push the switch in after it has returned to the center position.

Horn switch “”

Press this switch to sound the horn.

EAU12500

Engine stop switch “”

Set this switch to “” before starting the engine. Set this switch to “” to stop the engine in case of an emergency, such as when the vehicle overturns or when the throttle cable is stuck.

EAU12660

Start switch “”

With the sidestand up, push this switch while applying the front or rear brake to crank the engine with the starter. See page 5-1 for starting instructions prior to starting the engine.

EAU12721

EAU42340

The engine trouble warning light and ABS warning light will come on when

the key is turned to “ON” and the start switch is pushed, but this does not indicate a malfunction.

Hazard switch “”

With the key in the “ON” or “P<” position, use this switch to turn on the hazard lights (simultaneous flashing of all turn signal lights).

The hazard lights are used in case of an emergency or to warn other drivers when your vehicle is stopped where it might be a traffic hazard.

EAU12733

NOTICE

Do not use the hazard lights for an extended length of time with the engine not running, otherwise the battery may discharge.

ECA10061

Front brake lever

EAU44910

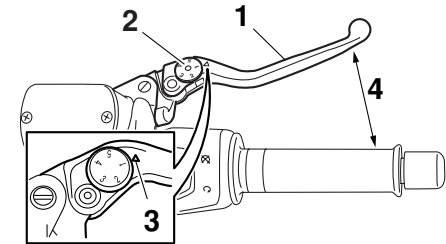

1. Front brake lever
2. Brake lever position adjusting dial
3. “” mark
4. Distance between brake lever and handlebar grip

The front brake lever is located at the right handlebar grip. To apply the front brake, pull this lever toward the handlebar grip.

The front brake lever is equipped with a position adjusting dial. To adjust the distance between the front brake lever and the handlebar grip, turn the adjusting dial while holding the front brake lever pushed away from the handlebar grip. Make sure that the appropriate

INSTRUMENT AND CONTROL FUNCTIONS

setting on the adjusting dial is aligned with the “△” mark on the front brake lever.

Rear brake lever

EAU44921

setting on the adjusting dial is aligned with the “△” mark on the rear brake lever.

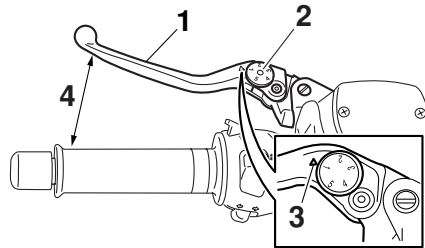

1. Rear brake lever
2. Brake lever position adjusting dial
3. “△” mark
4. Distance between brake lever and handlebar grip

The rear brake lever is located at the left handlebar grip. To apply the rear brake, pull this lever toward the handlebar grip.

The rear brake lever is equipped with a position adjusting dial. To adjust the distance between the rear brake lever and the handlebar grip, turn the adjusting dial while holding the rear brake lever pushed away from the handlebar grip. Make sure that the appropriate

Rear brake lock lever

EAU12962

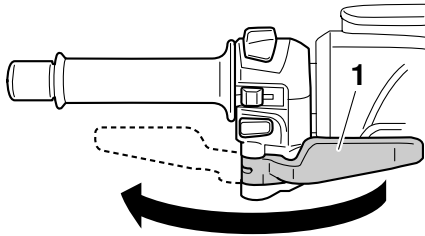

1. Rear brake lock lever

This vehicle is equipped with a rear brake lock lever to prevent the rear wheel from moving while stopped at traffic signals, railroad crossings, etc.

To lock the rear wheel

Push the rear brake lock lever to the left until it snaps into place.

To unlock the rear wheel

Push the rear brake lock lever back to the original position.

TIP

- Be sure to check that the rear wheel does not move when the

rear brake lock lever is applied.

- To provide secure locking of the rear wheel, apply the rear brake lever first before moving the rear brake lock lever to the left.

EWA12361

! WARNING

Never move the rear brake lock lever to the left while the vehicle is moving, otherwise loss of control or an accident may result. Make sure that the vehicle is stopped before moving the rear brake lock lever to the left.

ABS (for ABS models)

EAU12993

The Yamaha ABS (Anti-lock Brake System) features a dual electronic control system, which acts on the front and rear brakes independently. The ABS securely controls wheel lockup during emergency braking on changing road surfaces and under various weather conditions, thereby maximizing tire adhesion and performance while providing a smooth braking action. The ABS is monitored by an ECU (Electronic Control Unit), which will have recourse to manual braking if a malfunction occurs.

EWA10090

! WARNING

- The ABS performs best on long braking distances.
- On certain (rough or gravel) roads, the braking distance may be longer with than without the ABS. Therefore, always keep a sufficient distance to the vehicle ahead to match the riding speed.

INSTRUMENT AND CONTROL FUNCTIONS

EAU13175

TIP

- The ABS performs a self-diagnosis test for a few seconds each time the vehicle first starts off after the main switch was turned on. During this test, a “clicking” noise can be heard from the front of the vehicle, and if either brake lever is even slightly applied, a vibration can be felt at the lever, but these do not indicate a malfunction.
- When the ABS is activated, the brakes are operated in the usual way. A pulsating action may be felt at the brake levers, but this does not indicate a malfunction.
- This ABS has a test mode which allows the owner to experience the pulsating at the brake levers when the ABS is operating. However, special tools are required, so please consult your Yamaha dealer when performing this test.

ECA16120

NOTICE

Keep any type of magnets (including magnetic pick-up tools, magnetic

screwdrivers, etc.) away from the front and rear wheel hubs, otherwise the magnetic rotors equipped in the wheel hubs may be damaged, resulting in improper performance of the ABS system.

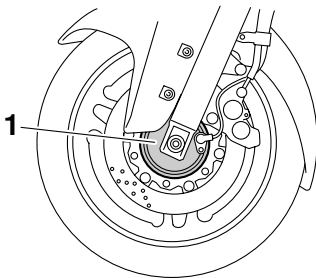

1. Front wheel hub

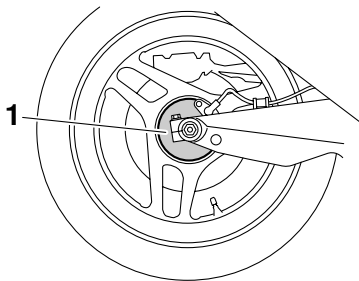

1. Rear wheel hub

Fuel tank cap

To remove the fuel tank cap

1. Open the lid by pulling the lever up.

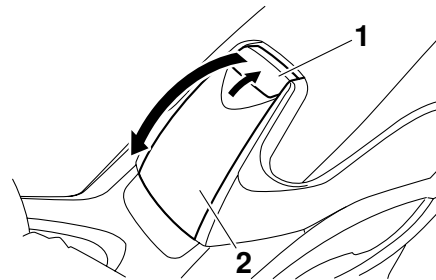

1. Opening lever
2. Lid

2. Insert the key into the lock and turn it clockwise. The lock will be released and the fuel tank cap can be removed.

INSTRUMENT AND CONTROL FUNCTIONS

EAU13212

Fuel

Make sure there is sufficient gasoline in the tank.

EWA10881

! WARNING

Gasoline and gasoline vapors are extremely flammable. To avoid fires and explosions and to reduce the risk of injury when refueling, follow these instructions.

1. Before refueling, turn off the engine and be sure that no one is sitting on the vehicle. Never refuel while smoking, or while in the vicinity of sparks, open flames, or other sources of ignition such as the pilot lights of water heaters and clothes dryers.
2. Do not overfill the fuel tank. Stop filling when the fuel reaches the bottom of the filler tube. Because fuel expands when it heats up, heat from the engine or the sun can cause fuel to spill out of the fuel tank.

move it.

3. Close the lid.

EWA11261

! WARNING

Make sure that the fuel tank cap is properly installed and locked in place before riding the scooter. Leaking fuel is a fire hazard.

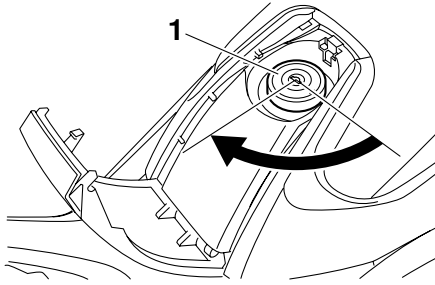

1. Fuel tank cap

To install the fuel tank cap

1. Align the match marks, insert the fuel tank cap into the tank opening, and then push down on the cap.

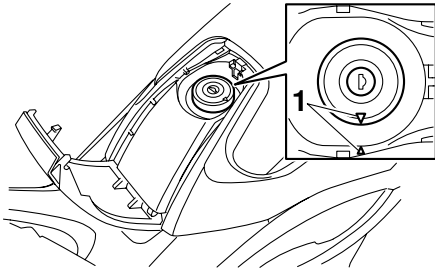

1. Match marks

2. Turn the key counterclockwise to the original position, and then re-

INSTRUMENT AND CONTROL FUNCTIONS

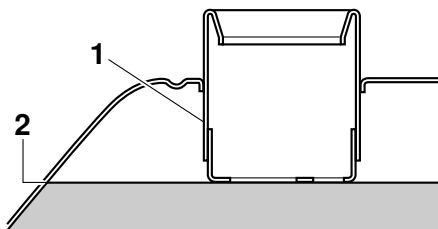

1. Fuel tank filler tube
2. Fuel level

3. Wipe up any spilled fuel immediately. **NOTICE: Immediately wipe off spilled fuel with a clean, dry, soft cloth, since fuel may deteriorate painted surfaces or plastic parts.**^[ECA10071]
4. Be sure to securely close the fuel tank cap.

EWA15151

⚠ WARNING

Gasoline is poisonous and can cause injury or death. Handle gasoline with care. Never siphon gasoline by mouth. If you should swallow some gasoline or inhale a lot of gasoline vapor, or get some gasoline in

your eyes, see your doctor immediately. If gasoline spills on your skin, wash with soap and water. If gasoline spills on your clothing, change your clothes.

and reduce maintenance costs.

EAU33520

Recommended fuel:
REGULAR UNLEADED GASOLINE
ONLY
Fuel tank capacity:
15.0 L (3.96 US gal, 3.30 Imp.gal)

ECA11400

NOTICE

Use only unleaded gasoline. The use of leaded gasoline will cause severe damage to internal engine parts, such as the valves and piston rings, as well as to the exhaust system.

Your Yamaha engine has been designed to use regular unleaded gasoline with a research octane number of 91 or higher. If knocking (or pinging) occurs, use a gasoline of a different brand or premium unleaded fuel. Use of unleaded fuel will extend spark plug life

EAU13432

Catalytic converter

This model is equipped with a catalytic converter in the exhaust system.

EWA10861

WARNING

The exhaust system is hot after operation. To prevent a fire hazard or burns:

- Do not park the vehicle near possible fire hazards such as grass or other materials that easily burn.
- Park the motorcycle in a place where pedestrians or children are not likely to touch the hot exhaust system.
- Make sure that the exhaust system has cooled down before doing any maintenance work.
- Do not allow the engine to idle more than a few minutes. Long idling can cause a build-up of heat.

ECA10701

NOTICE

Use only unleaded gasoline. The use of leaded gasoline will cause unre-

pairable damage to the catalytic converter.

EAU13932

Seat

To open the seat

1. Place the scooter on the center-stand.
2. Insert the key into the main switch, and then turn it counterclockwise to "OPEN".

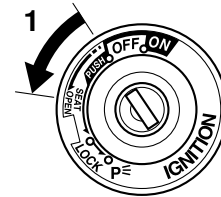

1. Open.

TIP

Do not push inward when turning the key.

3. Fold the seat up.

INSTRUMENT AND CONTROL FUNCTIONS

EAU14270

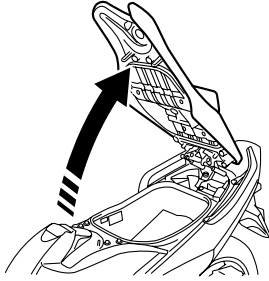

3

To close the seat

1. Fold the seat down, and then push it down to lock it in place.
2. Remove the key from the main switch if the scooter will be left unattended.

TIP

Make sure that the seat is properly secured before riding.

Adjusting the rider backrest

The rider backrest can be adjusted to the three different positions shown.

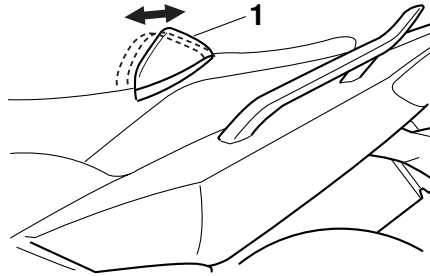

1. Rider backrest

Adjust the backrest as follows.

1. Open the seat. (See page 3-18.)
2. Remove the backrest bolts.

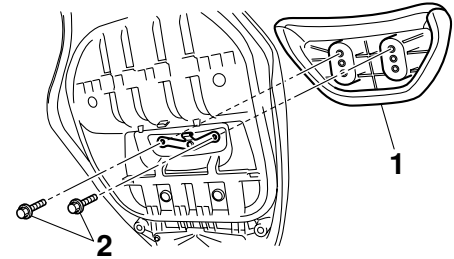

1. Rider backrest
2. Bolt

3. Slide the backrest forward or backward to the desired position.
4. Install and securely tighten the backrest bolts.
5. Close the seat.

EAU46300

Helmet holder

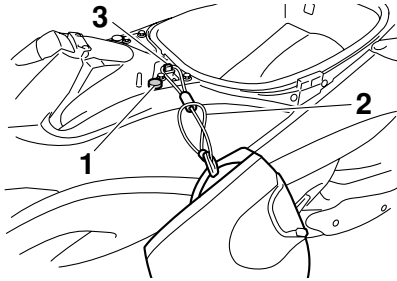

1. Shaded projection
2. Helmet holding cable
3. Helmet holder

The helmet holder is located under the seat. A helmet holding cable is provided beside the owner's tool kit to secure a helmet to the helmet holder.

To secure a helmet to the helmet holder

1. Open the seat. (See page 3-18.)
2. Pass the helmet holding cable through the buckle on the helmet strap as shown, and then hook the cable loop over the helmet holder.
3. Make sure the helmet holding ca-

ble is not touching the shaded projection, and securely close the seat. **WARNING! Never ride with a helmet attached to the helmet holder, since the helmet may hit objects, causing loss of control and possibly an accident.**^[EWA10161]

To release the helmet from the helmet holder

Open the seat, remove the helmet holding cable from the helmet holder and the helmet, and then close the seat.

EAU44993

Storage compartments

Front storage compartments A and B

To open a front storage compartment, slide the lever up, and then pull on the lever. **WARNING! Do not store heavy items in these compartments.**^[EWA14861]

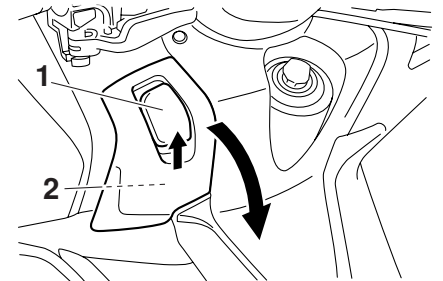

1. Storage compartment opening lever
2. Front storage compartment A

INSTRUMENT AND CONTROL FUNCTIONS

3

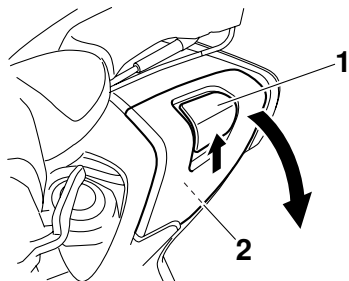

1. Storage compartment opening lever
2. Front storage compartment B

To close the front storage compartments, push the lid into the original position.

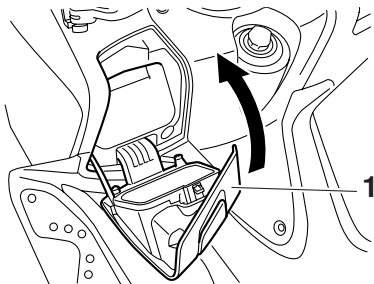

1. Storage compartment lid

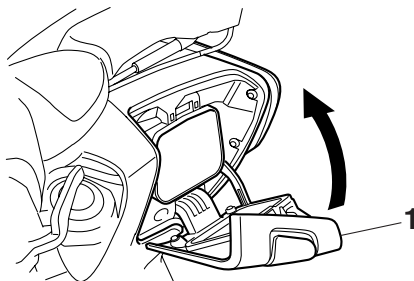

1. Storage compartment lid

Rear storage compartment

A helmet can be stored in the rear storage compartment under the seat. (See page 3-18.) To store a helmet in the rear storage compartment, place the helmet upside down with the front facing the left side. **NOTICE: Keep the following points in mind when using the storage compartment. Since the storage compartment accumulates heat when exposed to the sun, do not store anything susceptible to heat inside it. To avoid humidity from spreading through the storage compartment, wrap wet articles in a plastic bag before storing them in the compartment. Since the storage**

compartment may get wet while the scooter is being washed, wrap any articles stored in the compartment in a plastic bag. Do not keep anything valuable or breakable in the storage compartment. Do not leave the seat open for an extended period of time, otherwise the light may cause the battery to discharge.^[ECA16081]

NOTICE: The shaded area is not a storage compartment. To prevent damaging the seat hinges, do not place any items in this area.^[ECA16091]

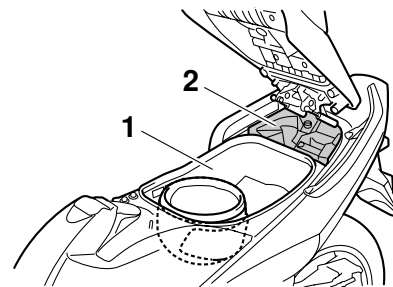

1. Rear storage compartment
2. Shaded area

TIP

- Some helmets cannot be stored in the rear storage compartment be-

INSTRUMENT AND CONTROL FUNCTIONS

cause of their size or shape.

- Do not leave your scooter untended with the seat open.

EWA11241

! WARNING

- Do not exceed the load limit of 5 kg (11 lb) for the rear storage compartment.
- Do not exceed the maximum load of XP500 194 kg (428 lb) XP500A 190 kg (419 lb) for the vehicle.

Rear view mirrors

EAU44970

The rear view mirrors of this vehicle can be folded backward for parking in narrow spaces. Fold the mirrors back to their original position before riding.

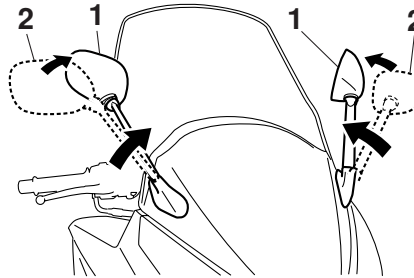

1. Parking position
2. Riding position

EWA14371

! WARNING

Be sure to fold the rear view mirrors back to their original position before riding.

Shock absorber assembly

EAU46021

EWA10221

! WARNING

This shock absorber assembly contains highly pressurized nitrogen gas. Read and understand the following information before handling the shock absorber assembly.

- Do not tamper with or attempt to open the cylinder assembly.
- Do not subject the shock absorber assembly to an open flame or other high heat source. This may cause the unit to explode due to excessive gas pressure.
- Do not deform or damage the cylinder in any way. Cylinder damage will result in poor damping performance.
- Do not dispose of a damaged or worn-out shock absorber assembly yourself. Take the shock absorber assembly to a Yamaha dealer for any service.

INSTRUMENT AND CONTROL FUNCTIONS

Sidestand

EAU15301

The sidestand is located on the left side of the frame. Raise the sidestand or lower it with your foot while holding the vehicle upright.

TIP

The built-in sidestand switch is part of the ignition circuit cut-off system, which cuts the ignition in certain situations. (See further down for an explanation of the ignition circuit cut-off system.)

EWA10240

WARNING

The vehicle must not be ridden with the sidestand down, or if the sidestand cannot be properly moved up (or does not stay up), otherwise the sidestand could contact the ground and distract the operator, resulting in a possible loss of control. Yamaha's ignition circuit cut-off system has been designed to assist the operator in fulfilling the responsibility of raising the sidestand before starting off. Therefore, check this system regularly as described below and have a Yamaha dealer re-

pair it if it does not function properly.

EAU45051

Ignition circuit cut-off system

The ignition circuit cut-off system (comprising the sidestand switch and brake light switches) has the following functions.

- It prevents starting when the sidestand is up, but neither brake is applied.
- It prevents starting when either brake is applied, but the sidestand is still down.
- It cuts the running engine when the sidestand is moved down.

Periodically check the operation of the ignition circuit cut-off system according to the following procedure.

INSTRUMENT AND CONTROL FUNCTIONS

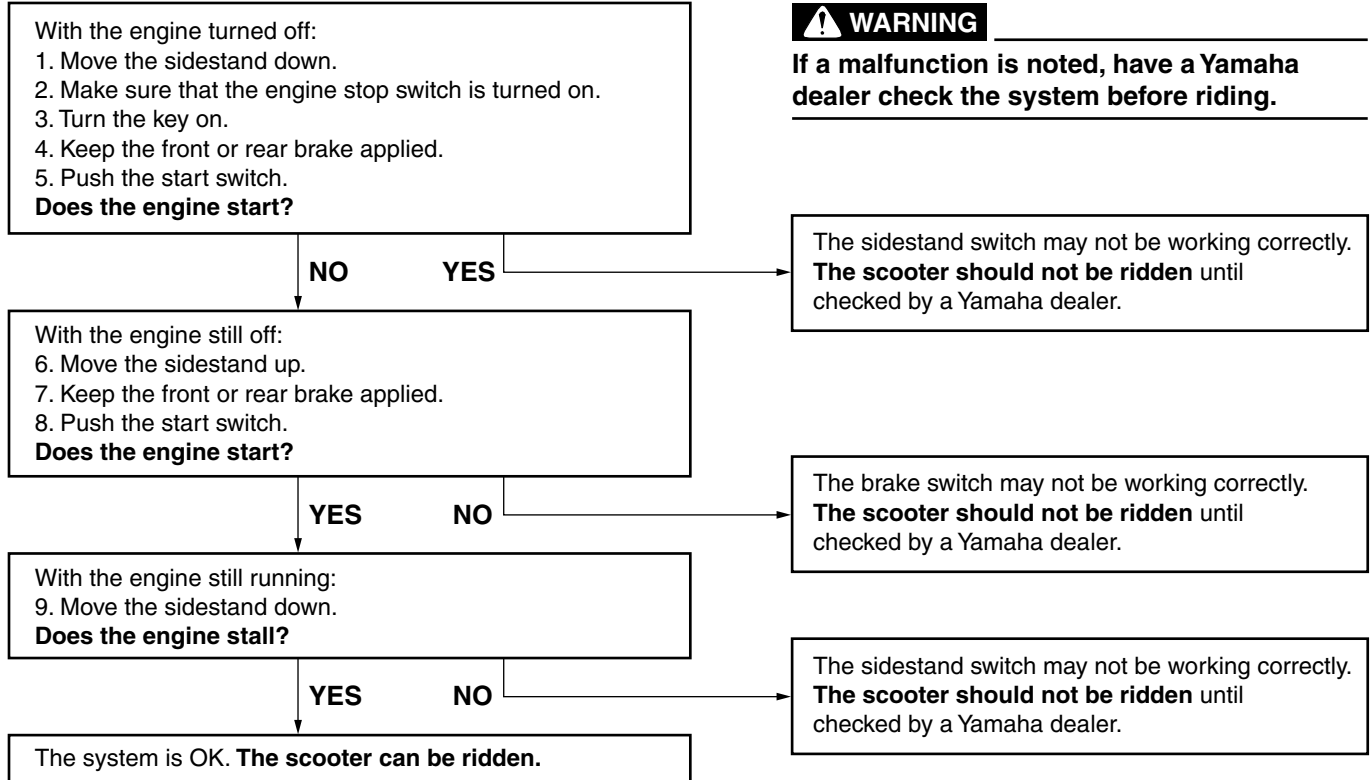

WARNING

If a malfunction is noted, have a Yamaha dealer check the system before riding.

FOR YOUR SAFETY – PRE-OPERATION CHECKS

EAU15596

Inspect your vehicle each time you use it to make sure the vehicle is in safe operating condition. Always follow the inspection and maintenance procedures and schedules described in the Owner's Manual.

EWA11151

WARNING

Failure to inspect or maintain the vehicle properly increases the possibility of an accident or equipment damage. Do not operate the vehicle if you find any problem. If a problem cannot be corrected by the procedures provided in this manual, have the vehicle inspected by a Yamaha dealer.

Before using this vehicle, check the following points:

ITEM	CHECKS	PAGE
Fuel	<ul style="list-style-type: none">• Check fuel level in fuel tank.• Refuel if necessary.• Check fuel line for leakage.	3-16
Engine oil	<ul style="list-style-type: none">• Check oil level in engine.• If necessary, add recommended oil to specified level.• Check vehicle for oil leakage.	6-11
Chain drive oil	<ul style="list-style-type: none">• Check vehicle for oil leakage.	6-14
Coolant	<ul style="list-style-type: none">• Check coolant level in reservoir.• If necessary, add recommended coolant to specified level.• Check cooling system for leakage.	6-15
Front brake	<ul style="list-style-type: none">• Check operation.• If soft or spongy, have Yamaha dealer bleed hydraulic system.• Check brake pads for wear.• Replace if necessary.• Check fluid level in reservoir.• If necessary, add recommended brake fluid to specified level.• Check hydraulic system for leakage.	6-21, 6-22, 6-23

FOR YOUR SAFETY – PRE-OPERATION CHECKS

ITEM	CHECKS	PAGE
Rear brake	<ul style="list-style-type: none"> • Check operation. • If soft or spongy, have Yamaha dealer bleed hydraulic system. • Check brake pads for wear. • Replace if necessary. • Check fluid level in reservoir. • If necessary, add recommended brake fluid to specified level. • Check hydraulic system for leakage. 	6-21, 6-22, 6-23
Throttle grip	<ul style="list-style-type: none"> • Make sure that operation is smooth. • Check cable free play. • If necessary, have Yamaha dealer adjust cable free play and lubricate cable and grip housing. 	6-18, 6-24
Wheels and tires	<ul style="list-style-type: none"> • Check for damage. • Check tire condition and tread depth. • Check air pressure. • Correct if necessary. 	6-19, 6-20
Brake levers	<ul style="list-style-type: none"> • Make sure that operation is smooth. • Lubricate lever pivoting points if necessary. 	6-25
Centerstand, sidestand	<ul style="list-style-type: none"> • Make sure that operation is smooth. • Lubricate pivots if necessary. 	6-25
Chassis fasteners	<ul style="list-style-type: none"> • Make sure that all nuts, bolts and screws are properly tightened. • Tighten if necessary. 	—
Instruments, lights, signals and switches	<ul style="list-style-type: none"> • Check operation. • Correct if necessary. 	—
Sidestand switch	<ul style="list-style-type: none"> • Check operation of ignition circuit cut-off system. • If system is not working correctly, have Yamaha dealer check vehicle. 	3-23

OPERATION AND IMPORTANT RIDING POINTS

EAU15951

Read the Owner's Manual carefully to become familiar with all controls. If there is a control or function you do not understand, ask your Yamaha dealer.

EWA10271

WARNING

Failure to familiarize yourself with the controls can lead to loss of control, which could cause an accident or injury.

EAU45310

TIP

This model is equipped with a lean angle sensor to stop the engine in case of a turnover. To start the engine after a turnover, be sure to turn the main switch to "OFF" and then to "ON". Failing to do so will prevent the engine from starting even though the engine will crank when pushing the start switch.

EAU36512

Starting the engine

ECA10250

NOTICE

See page 5-4 for engine break-in instructions prior to operating the vehicle for the first time.

In order for the ignition circuit cut-off system to enable starting, the side-stand must be up.

See page 3-23 for more information.

1. Turn the key to "ON" and make sure that the engine stop switch is set to "○".

The following warning lights, indicator light and indicators should come on for a few seconds, then go off.

- Engine trouble warning light
- ABS warning light (for ABS models)
- Immobilizer system indicator light
- V-belt replacement indicator
- Oil change indicator

ECA15022

NOTICE

If a warning light, indicator light or indicator does not go off, see pages

OPERATION AND IMPORTANT RIDING POINTS

3-3, 3-8, 3-9 or 3-6 for the corresponding warning light, indicator light or indicator circuit check.

2. Close the throttle completely.
3. Start the engine by pushing the start switch while applying the front or rear brake. **NOTICE: For maximum engine life, never accelerate hard when the engine is cold!**^[ECA11041]

If the engine does not start, release the start switch, wait a few seconds, and then try again. Each starting attempt should be as short as possible to preserve the battery. Do not crank the engine more than 10 seconds on any one attempt.

Starting off

EAU45091

1. While pulling the rear brake lever with your left hand and holding the grab bar with your right hand, push the scooter off the centerstand.

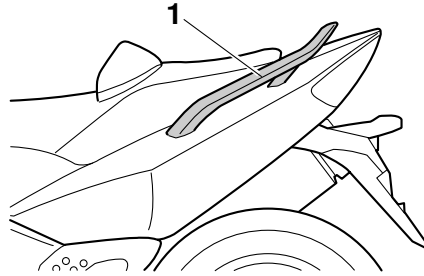

1. Grab bar
2. Sit astride the seat, and then adjust the rear view mirrors.
3. Switch the turn signals on.
4. Check for oncoming traffic, and then slowly turn the throttle grip (on the right) in order to take off.
5. Switch the turn signals off.

Acceleration and deceleration

EAU16780

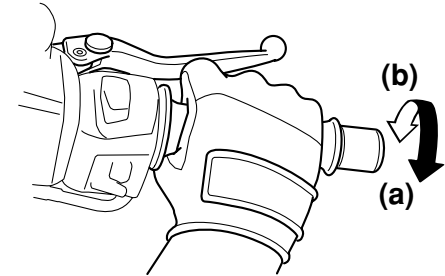

The speed can be adjusted by opening and closing the throttle. To increase the speed, turn the throttle grip in direction (a). To reduce the speed, turn the throttle grip in direction (b).

OPERATION AND IMPORTANT RIDING POINTS

Braking

EAU16793

EWA10300

WARNING

- Avoid braking hard or suddenly (especially when leaning over to one side), otherwise the scooter may skid or overturn.
- Railroad crossings, streetcar rails, iron plates on road construction sites, and manhole covers become extremely slippery when wet. Therefore, slow down when approaching such areas and cross them with caution.
- Keep in mind that braking on a wet road is much more difficult.
- Ride slowly down a hill, as braking downhill can be very difficult.

1. Close the throttle completely.
2. Apply both front and rear brakes simultaneously while gradually increasing the pressure.

Front

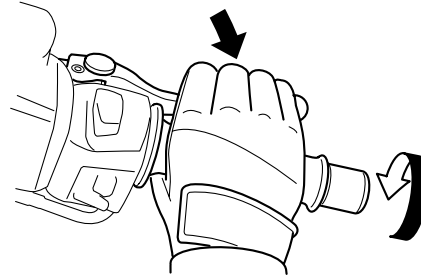

Rear

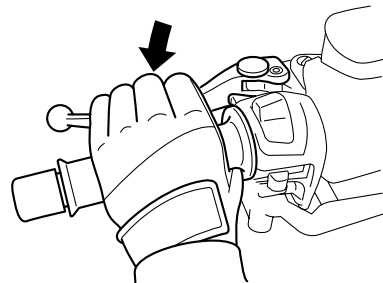

EAU16820

Tips for reducing fuel consumption

Fuel consumption depends largely on your riding style. Consider the following tips to reduce fuel consumption:

- Avoid high engine speeds during acceleration.
- Avoid high engine speeds with no load on the engine.
- Turn the engine off instead of letting it idle for an extended length of time (e.g., in traffic jams, at traffic lights or at railroad crossings).

OPERATION AND IMPORTANT RIDING POINTS

Engine break-in

EAU16841

There is never a more important period in the life of your engine than the period between 0 and 1600 km (1000 mi). For this reason, you should read the following material carefully.

Since the engine is brand new, do not put an excessive load on it for the first 1600 km (1000 mi). The various parts in the engine wear and polish themselves to the correct operating clearances. During this period, prolonged full-throttle operation or any condition that might result in engine overheating must be avoided.

EAU36531

0–1000 km (0–600 mi)

Avoid prolonged operation above 4000 r/min. **NOTICE: After 1000 km (600 mi) of operation, the engine oil must be changed, and the oil filter cartridge or element replaced.**^[ECA11282]

1000–1600 km (600–1000 mi)

Avoid prolonged operation above 6000 r/min.

1600 km (1000 mi) and beyond

The vehicle can now be operated normally.

ECA10310

NOTICE

- Keep the engine speed out of the tachometer red zone.
- If any engine trouble should occur during the engine break-in period, immediately have a Yamaha dealer check the vehicle.

EAU17213

Parking

When parking, stop the engine, and then remove the key from the main switch.

EWA10311

WARNING

- Since the engine and exhaust system can become very hot, park in a place where pedestrians or children are not likely to touch them and be burned.
- Do not park on a slope or on soft ground, otherwise the vehicle may overturn, increasing the risk of a fuel leak and fire.
- Do not park near grass or other flammable materials which might catch fire.

PERIODIC MAINTENANCE AND ADJUSTMENT

EAU17281

Periodic inspection, adjustment, and lubrication will keep your vehicle in the safest and most efficient condition possible. Safety is an obligation of the vehicle owner/operator. The most important points of vehicle inspection, adjustment, and lubrication are explained on the following pages.

The intervals given in the periodic maintenance and lubrication chart should be simply considered as a general guide under normal riding conditions. However, depending on the weather, terrain, geographical location, and individual use, the maintenance intervals may need to be shortened.

EWA10321

WARNING

Failure to properly maintain the vehicle or performing maintenance activities incorrectly may increase your risk of injury or death during service or while using the vehicle. If you are not familiar with vehicle service, have a Yamaha dealer perform service.

EWA15121

WARNING

Turn off the engine when performing maintenance unless otherwise specified.

- **A running engine has moving parts that can catch on body parts or clothing and electrical parts that can cause shocks or fires.**
- **Running the engine while servicing can lead to eye injury, burns, fire, or carbon monoxide poisoning – possibly leading to death. See page 1-1 for more information about carbon monoxide.**

EWA10330

WARNING

This scooter is designed for use on paved roads only. If this scooter is operated in abnormally dusty, muddy or wet conditions, the air filter element should be cleaned or replaced more frequently, otherwise rapid engine wear may result. Consult a Yamaha dealer for proper

maintenance intervals.

EAU17391

Owner's tool kit

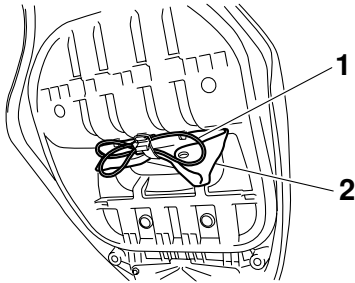

1. Helmet holding cable
2. Owner's tool kit

The owner's tool kit is located under the seat. (See page 3-18.)

The service information included in this manual and the tools provided in the owner's tool kit are intended to assist you in the performance of preventive maintenance and minor repairs. However, additional tools such as a torque wrench may be necessary to perform certain maintenance work correctly.

TIP

If you do not have the tools or experience required for a particular job, have a Yamaha dealer perform it for you.

PERIODIC MAINTENANCE AND ADJUSTMENT

EAU1770A

Periodic maintenance and lubrication chart

TIP

- The annual checks must be performed every year, except if a kilometer-based maintenance, or for the UK, a mileage-based maintenance, is performed instead.
- From 50000 km (30000 mi), repeat the maintenance intervals starting from 10000 km (6000 mi).
- Items marked with an asterisk should be performed by a Yamaha dealer as they require special tools, data and technical skills.

NO.	ITEM	CHECK OR MAINTENANCE JOB	ODOMETER READING					ANNUAL CHECK
			1000 km (600 mi)	10000 km (6000 mi)	20000 km (12000 mi)	30000 km (18000 mi)	40000 km (24000 mi)	
1	* Fuel line	<ul style="list-style-type: none"> ● Check fuel hoses for cracks or damage. 		√	√	√	√	√
2	* Spark plugs	<ul style="list-style-type: none"> ● Check condition. ● Clean and regap. 		√		√		
		<ul style="list-style-type: none"> ● Replace. 			√		√	
3	* Valves	<ul style="list-style-type: none"> ● Check valve clearance. ● Adjust. 	Every 40000 km (24000 mi)					
4	Air filter element	<ul style="list-style-type: none"> ● Replace. 			√		√	
5	* V-belt case air filter elements	<ul style="list-style-type: none"> ● Clean. 		√		√		
		<ul style="list-style-type: none"> ● Replace. 			√		√	
6	* Front brake	<ul style="list-style-type: none"> ● Check operation, fluid level and vehicle for fluid leakage. 	√	√	√	√	√	√
		<ul style="list-style-type: none"> ● Replace brake pads. 	Whenever worn to the limit					
7	* Rear brake	<ul style="list-style-type: none"> ● Check operation, fluid level and vehicle for fluid leakage. 	√	√	√	√	√	√
		<ul style="list-style-type: none"> ● Replace brake pads. 	Whenever worn to the limit					
8	Rear brake lock	<ul style="list-style-type: none"> ● Check operation. ● Adjust. 	√	√	√	√	√	√

PERIODIC MAINTENANCE AND ADJUSTMENT

NO.	ITEM	CHECK OR MAINTENANCE JOB	ODOMETER READING					ANNUAL CHECK
			1000 km (600 mi)	10000 km (6000 mi)	20000 km (12000 mi)	30000 km (18000 mi)	40000 km (24000 mi)	
9	* Brake hoses	• Check for cracks or damage.		√	√	√	√	√
		• Replace.	Every 4 years					
10	* Wheels	• Check runout and for damage.		√	√	√	√	
11	* Tires	• Check tread depth and for damage.						
		• Replace if necessary. • Check air pressure. • Correct if necessary.		√	√	√	√	√
12	* Wheel bearings	• Check bearing for looseness or damage.		√	√	√	√	
13	* Steering bearings	• Check bearing play and steering for roughness.	√	√	√	√	√	
		• Lubricate with lithium-soap-based grease.	Every 20000 km (12000 mi)					
14	* Chassis fasteners	• Make sure that all nuts, bolts and screws are properly tightened.		√	√	√	√	√
15	Front brake lever pivot shaft	• Lubricate with silicone grease.		√	√	√	√	√
16	Rear brake lever pivot shaft	• Lubricate with silicone grease.		√	√	√	√	√
17	Sidestand, center-stand	• Check operation. • Lubricate.		√	√	√	√	√
18	* Sidestand switch	• Check operation.	√	√	√	√	√	√
19	* Front fork	• Check operation and for oil leakage.		√	√	√	√	
20	* Shock absorber assembly	• Check operation and shock absorber for oil leakage.		√	√	√	√	
21	* Fuel injection	• Adjust engine idling speed and synchronization.	√	√	√	√	√	√

PERIODIC MAINTENANCE AND ADJUSTMENT

NO.	ITEM	CHECK OR MAINTENANCE JOB	ODOMETER READING					ANNUAL CHECK
			1000 km (600 mi)	10000 km (6000 mi)	20000 km (12000 mi)	30000 km (18000 mi)	40000 km (24000 mi)	
22	Engine oil	<ul style="list-style-type: none"> Change. (See pages 3-8 and 6-11.) 	√	When the oil change indicator flashes				
		<ul style="list-style-type: none"> Check oil level and vehicle for oil leakage. 	Every 5000 km (3000 mi)					√
23	Engine oil filter cartridge	<ul style="list-style-type: none"> Replace. 	√		√		√	
24	* Cooling system	<ul style="list-style-type: none"> Check coolant level and vehicle for coolant leakage. 		√	√	√	√	√
		<ul style="list-style-type: none"> Change. 	Every 3 years					
25	Chain drive oil	<ul style="list-style-type: none"> Check vehicle for oil leakage. Change. 		√	√	√	√	
26	* V-belt	<ul style="list-style-type: none"> Replace. 	When the V-belt replacement indicator flashes [every 20000 km (12000 mi)]					
27	* Front and rear brake switches	<ul style="list-style-type: none"> Check operation. 	√	√	√	√	√	√
28	Moving parts and cables	<ul style="list-style-type: none"> Lubricate. 		√	√	√	√	√
29	* Throttle grip housing and cable	<ul style="list-style-type: none"> Check operation and free play. Adjust the throttle cable free play if necessary. Lubricate the throttle grip housing and cable. 		√	√	√	√	√
30	* Lights, signals and switches	<ul style="list-style-type: none"> Check operation. Adjust headlight beam. 	√	√	√	√	√	√

PERIODIC MAINTENANCE AND ADJUSTMENT

EAU38262

TIP

- Engine air filter and V-belt air filters
 - This model's engine air filter is equipped with a disposable oil-coated paper element, which must not be cleaned with compressed air to avoid damaging it.
 - The engine air filter element needs to be replaced and the V-belt air filter elements need to be serviced more frequently when riding in unusually wet or dusty areas.
 - Hydraulic brake service
 - After disassembling the brake master cylinders and calipers, always change the fluid. Regularly check the brake fluid levels and fill the reservoirs as required.
 - Every two years replace the internal components of the brake master cylinders and calipers, and change the brake fluid.
 - Replace the brake hoses every four years and if cracked or damaged.
-

PERIODIC MAINTENANCE AND ADJUSTMENT

EAU18771

Removing and installing panels

The panels shown need to be removed to perform some of the maintenance jobs described in this chapter. Refer to this section each time a panel needs to be removed and installed.

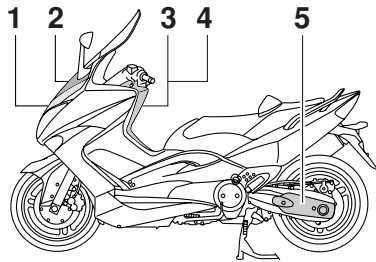

- 1. Panel A
- 2. Panel B
- 3. Panel C
- 4. Panel D
- 5. Panel E

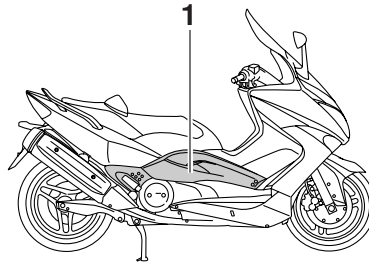

- 1. Panel F

EAU45012

Panel A

To remove the panel

- 1. Remove the quick fasteners.

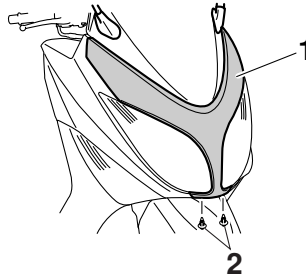

- 1. Panel A
- 2. Quick fastener

- 2. Remove the upper left and right side of the panel by pulling them upward, and then pull the panel downward as shown.

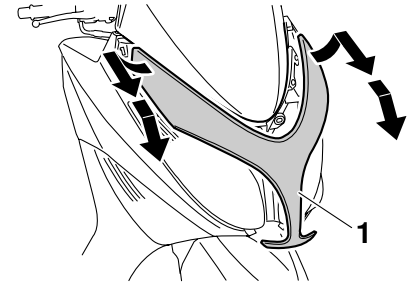

- 1. Panel A

To install the panel

Place the panel in the original position, and then install the quick fasteners.

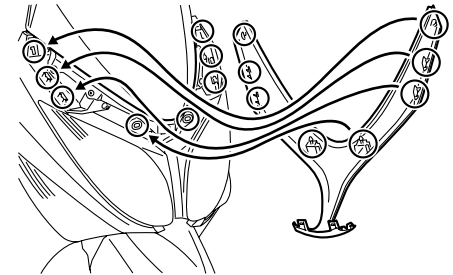

PERIODIC MAINTENANCE AND ADJUSTMENT

Panel B

To remove the panel

1. Remove panel A.
2. Pull the rear view mirror rubber cover on each mirror upward, and then remove the rear view mirrors by removing the nuts.

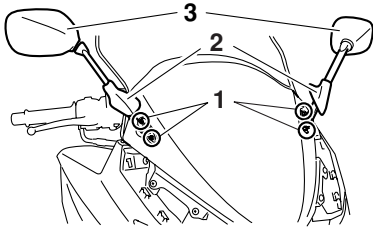

1. Nut
2. Rubber cover
3. Rear view mirror

3. Remove the screws, and then pull the panel outward.

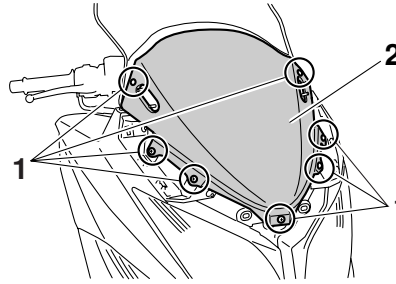

1. Screw
2. Panel B

To install the panel

1. Place the panel in the original position, and then install the screws.
2. Install the rear view mirrors by installing the nuts, and then place the rubber cover on each mirror in the original position.
3. Install panel A.

Panel C

To remove the panel

Remove the screws, and then pull the panel upward.

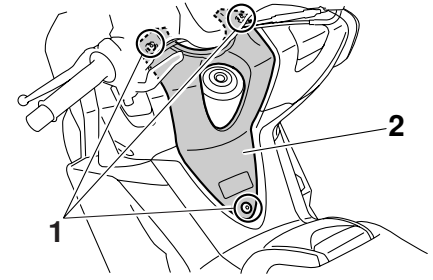

1. Screw
2. Panel C

To install the panel

Place the panel in the original position, and then install the screws.

Panel D

To remove the panel

1. Remove panel C.
2. Remove the screws, and then pull the panel backward and upward.

PERIODIC MAINTENANCE AND ADJUSTMENT

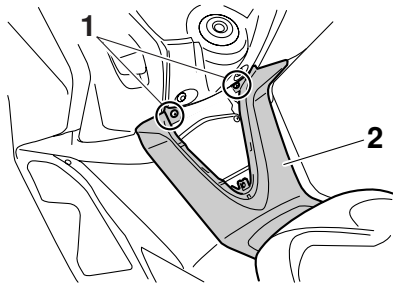

1. Screw
2. Panel D

To install the panel

1. Place the panel in the original position, and then install the screws.
2. Install panel C.

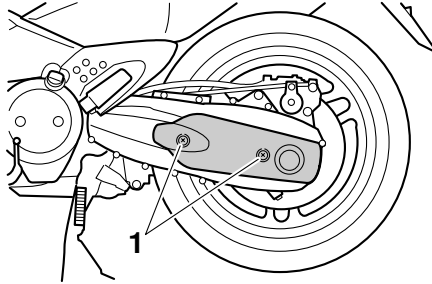

1. Screw

To install the panel

Place the panel in the original position, and then install the screws.

Panel F

To remove the panel

Remove the screws, and then pull the panel outward.

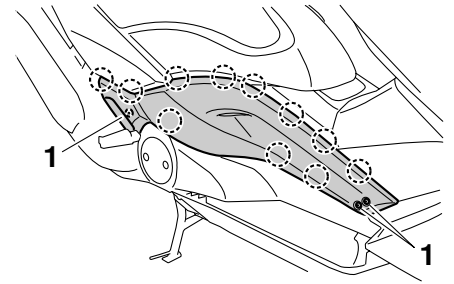

1. Screw

To install the panel

Place the panel in the original position, and then install the screws.

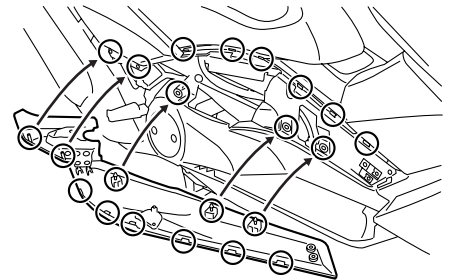

Panel E

To remove the panel

Remove the screws, and then pull the panel outward.

PERIODIC MAINTENANCE AND ADJUSTMENT

EAU19642

Checking the spark plugs

The spark plugs are important engine components, which should be checked periodically, preferably by a Yamaha dealer. Since heat and deposits will cause any spark plug to slowly erode, they should be removed and checked in accordance with the periodic maintenance and lubrication chart. In addition, the condition of the spark plugs can reveal the condition of the engine.

The porcelain insulator around the center electrode of each spark plug should be a medium-to-light tan (the ideal color when the vehicle is ridden normally), and all spark plugs installed in the engine should have the same color. If any spark plug shows a distinctly different color, the engine could be operating improperly. Do not attempt to diagnose such problems yourself. Instead, have a Yamaha dealer check the vehicle.

If a spark plug shows signs of electrode erosion and excessive carbon or other deposits, it should be replaced.

Specified spark plug:
NGK/CR7E

Before installing a spark plug, the spark plug gap should be measured with a wire thickness gauge and, if necessary, adjusted to specification.

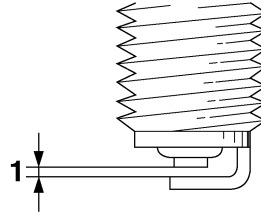

1. Spark plug gap

Spark plug gap:
0.7–0.8 mm (0.028–0.031 in)

Clean the surface of the spark plug gasket and its mating surface, and then wipe off any grime from the spark plug threads.

Tightening torque:
Spark plug:
12.5 Nm (1.25 m·kgf, 9 ft·lbf)

TIP _____
If a torque wrench is not available when

installing a spark plug, a good estimate of the correct torque is 1/4–1/2 turn past finger tight. However, the spark plug should be tightened to the specified torque as soon as possible.

PERIODIC MAINTENANCE AND ADJUSTMENT

EAU1985B

Engine oil and oil filter cartridge

The engine oil level should be checked before each ride. In addition, the oil must be changed and the oil filter cartridge replaced at the intervals specified in the periodic maintenance and lubrication chart.

To check the engine oil level

1. Place the vehicle on the center-stand. A slight tilt to the side can result in a false reading.
2. Start the engine, warm it up for two minutes, and then turn it off.

ECA11290

NOTICE

The engine must be cold before proceeding with the oil level check, otherwise the check will result in a false reading.

3. Wait two minutes until the oil settles, and then check the oil level through the check window located at the bottom-left side of the crankcase.

TIP

The engine oil should be between the minimum and maximum level marks.

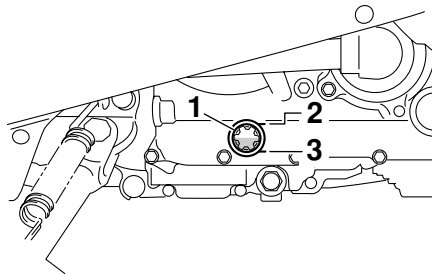

1. Engine oil level check window
2. Maximum level mark
3. Minimum level mark

4. If the engine oil is below the minimum level mark, add sufficient oil of the recommended type to raise it to the correct level.

To change the engine oil (with or without oil filter cartridge replacement)

1. Place the vehicle on a level surface.
2. Start the engine, warm it up for

several minutes, and then turn it off.

3. Place an oil pan under the engine to collect the used oil.
4. Remove the engine oil filler cap and drain bolt to drain the oil from the crankcase.

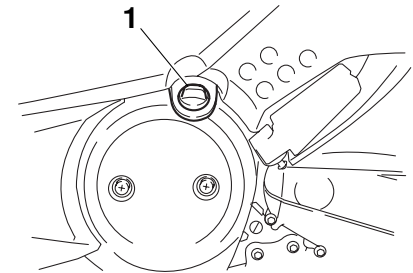

1. Engine oil filler cap

PERIODIC MAINTENANCE AND ADJUSTMENT

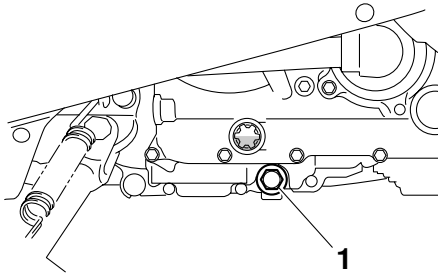

1. Engine oil drain bolt

5. Check the washer and O-ring for damage and replace them if necessary.

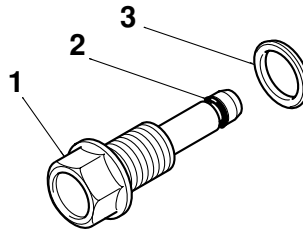

- 1. Engine oil drain bolt
- 2. O-ring
- 3. Washer

TIP _____
Skip steps 6–8 if the oil filter cartridge is not being replaced.

6. Remove the oil filter cartridge with an oil filter wrench.

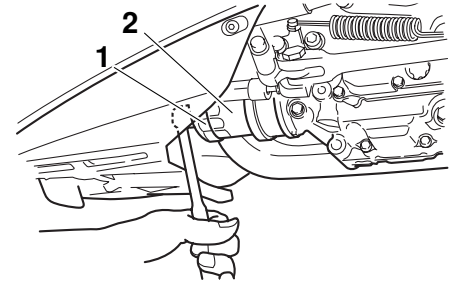

- 1. Oil filter wrench
- 2. Oil filter cartridge

TIP _____
An oil filter wrench is available at a Yamaha dealer.

7. Apply a thin coat of clean engine oil to the O-ring of the new oil filter cartridge.

TIP _____
Make sure that the O-ring is properly seated.

8. Install the new oil filter cartridge, and then tighten it to the specified torque with a torque wrench.

PERIODIC MAINTENANCE AND ADJUSTMENT

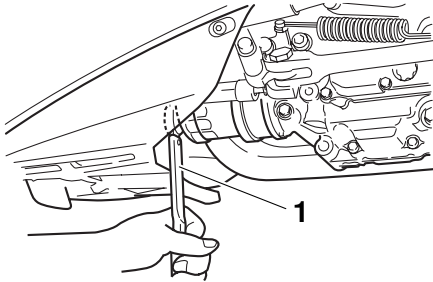

1. Torque wrench

Tightening torque:

Oil filter cartridge:
17 Nm (1.7 m·kgf, 12.3 ft·lbf)

9. Install the engine oil drain bolt, and then tighten it to the specified torque.

Tightening torque:

Engine oil drain bolt:
43 Nm (4.3 m·kgf, 31.1 ft·lbf)

10. Refill with the specified amount of the recommended engine oil, and then install and tighten the oil filler cap.

Recommended engine oil:

See page 8-1.

Oil quantity:

Without oil filter cartridge replacement:

2.80 L (2.96 US qt, 2.46 Imp.qt)

With oil filter cartridge replacement:

2.90 L (3.07 US qt, 2.55 Imp.qt)

TIP

Be sure to wipe off spilled oil on any parts after the engine and exhaust system have cooled down.

ECA11620

NOTICE

- In order to prevent clutch slippage (since the engine oil also lubricates the clutch), do not mix any chemical additives. Do not use oils with a diesel specification of “CD” or oils of a higher quality than specified. In addition, do not use oils labeled “ENERGY CONSERVING II” or higher.
- Make sure that no foreign material enters the crankcase.

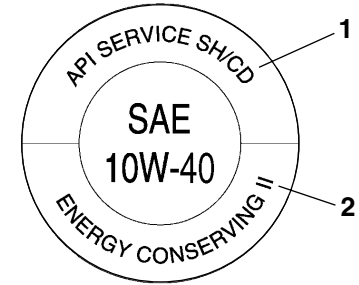

1. “CD” specification
2. “ENERGY CONSERVING II”

11. Start the engine, and then let it idle for several minutes while checking for oil leakage. If oil is leaking, immediately turn the engine off and check for the cause.
12. Turn the engine off, and then check the oil level and correct it if necessary.
13. Reset the oil change indicator. (See page 3-8.)

TIP

If the engine oil is changed before the oil change indicator comes on (i.e. before the periodic oil change interval has been reached), the indicator must be reset after the oil change for the next

PERIODIC MAINTENANCE AND ADJUSTMENT

periodic oil change to be indicated at the correct time.

Chain drive oil

EAU19996

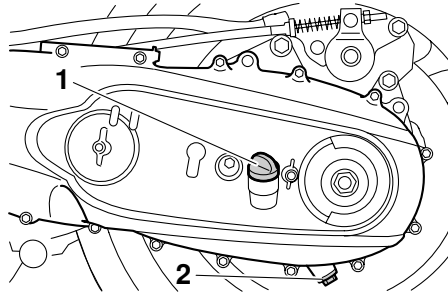

1. Chain drive oil filler cap
2. Chain drive oil drain bolt

The chain drive oil should be changed as follows at the intervals specified in the periodic maintenance and lubrication chart.

1. Place the vehicle on a level surface.
2. Remove panel E. (See page 6-7.)
3. Place an oil pan under the chain drive case to collect the used oil.
4. Remove the oil filler cap and drain bolt to drain the oil from the chain drive case.
5. Install the chain drive oil drain bolt, and then tighten it to the specified

torque.

Tightening torque:

Chain drive oil drain bolt:
20 Nm (2.0 m·kgf, 14.5 ft·lbf)

6. Refill with the specified amount of the recommended oil.

Recommended chain drive oil:

See page 8-1.

Oil quantity:

0.70 L (0.74 US qt, 0.62 Imp.qt)

7. Wipe the dipstick clean, insert it into the oil filler hole (without screwing it in), and then remove it to check the oil level.

TIP

The chain drive oil should be between the minimum and maximum level marks.

PERIODIC MAINTENANCE AND ADJUSTMENT

11. Install the panel.

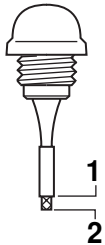

1. Maximum level mark
2. Minimum level mark

8. If the chain drive oil is below the minimum level mark, add sufficient oil of the recommended type to raise it to the correct level.
9. Insert the dipstick into the oil filler hole, and then tighten the oil filler cap.

ECA15010

NOTICE

- **Make sure that no foreign material enters the chain drive case.**
- **Make sure that no oil gets on the tire or wheel.**

10. Check the chain drive case for oil leakage. If leakage is found, check for the cause.

EAU20070

Coolant

The coolant level should be checked before each ride. In addition, the coolant must be changed at the intervals specified in the periodic maintenance and lubrication chart.

EAU46330

To check the coolant level

1. Place the vehicle on the center-stand.

TIP

- The coolant level must be checked on a cold engine since the level varies with engine temperature.
- Make sure that the vehicle is positioned straight up when checking the coolant level. A slight tilt to the side can result in a false reading.

2. Check the coolant level through the check window.

TIP

The coolant should be between the minimum and maximum level marks.

PERIODIC MAINTENANCE AND ADJUSTMENT

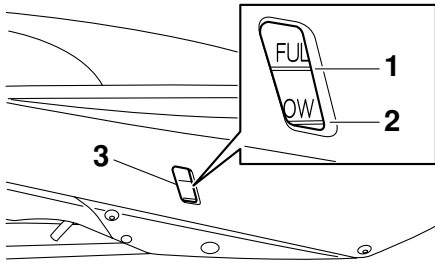

1. Maximum level mark
2. Minimum level mark
3. Coolant level check window

3. If the coolant is at or below the minimum level mark, lift up the right floorboard mat as shown.

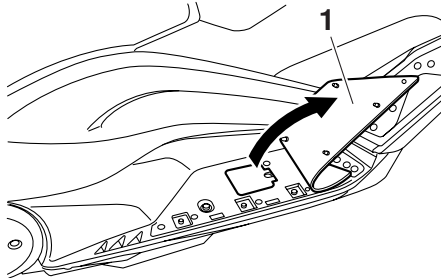

1. Right floorboard mat
4. Remove the coolant reservoir cov-

er by removing the screw.

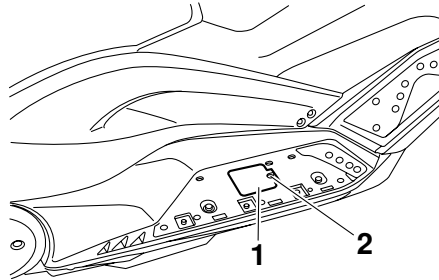

1. Coolant reservoir cover
2. Screw

5. Open the reservoir cap, add coolant to the maximum level mark, and then close the reservoir cap. **WARNING! Remove only the coolant reservoir cap. Never attempt to remove the radiator cap when the engine is hot.**^[EWA15161] **NOTICE: If coolant is not available, use distilled water or soft tap water instead. Do not use hard water or salt water since it is harmful to the engine. If water has been used instead of coolant, replace it with coolant as soon as possible, other-**

wise the cooling system will not be protected against frost and corrosion. If water has been added to the coolant, have a Yamaha dealer check the anti-freeze content of the coolant as soon as possible, otherwise the effectiveness of the coolant will be reduced.^[ECA10472]

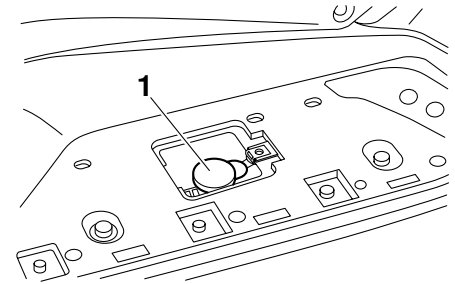

1. Coolant reservoir cap

Coolant reservoir capacity (up to the maximum level mark):

0.25 L (0.26 US qt, 0.22 Imp.qt)

6. Install the coolant reservoir cover by installing the screw.
7. Place the right floorboard mat in the original position.

PERIODIC MAINTENANCE AND ADJUSTMENT

EAU45021

Replacing the air filter element

The air filter element should be replaced at the intervals specified in the periodic maintenance and lubrication chart. Replace the air filter element more frequently if you are riding in unusually wet or dusty areas.

To replace the air filter element

1. Remove panels C and D. (See page 6-7.)
2. Remove the air filter case cover by removing the screws.

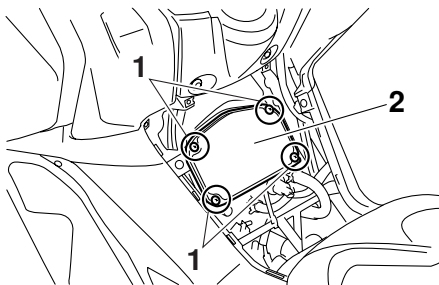

1. Screw
2. Air filter case cover

3. Pull the air filter element out.

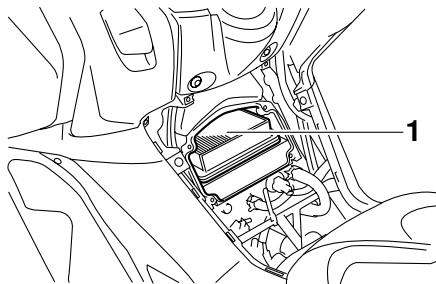

1. Air filter element

4. Insert a new air filter element into the air filter case. **NOTICE: Make sure that the air filter element is properly seated in the air filter case. The engine should never be operated without the air filter element installed, otherwise the piston(s) and/or cylinder(s) may become excessively worn.**^[ECA10481]
5. Install the air filter case cover by installing the screws.
6. Install the panels.

EAU33482

Adjusting the engine idling speed

The engine idling speed must be checked and, if necessary, adjusted as follows at the intervals specified in the periodic maintenance and lubrication chart.

The engine should be warm before making this adjustment.

1. Remove panel F. (See page 6-7.)
2. Check the engine idling speed and, if necessary, adjust it to specification by turning the idle adjusting screw. To increase the engine idling speed, turn the screw in direction (a). To decrease the engine idling speed, turn the screw in direction (b).

PERIODIC MAINTENANCE AND ADJUSTMENT

EAU21382

EAU21401

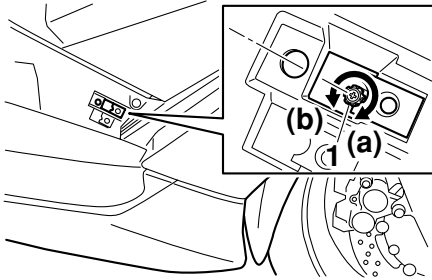

1. Idle adjusting screw

Engine idling speed:
1100–1300 r/min

TIP

If the specified idling speed cannot be obtained as described above, have a Yamaha dealer make the adjustment.

3. Install the panel.

Checking the throttle cable free play

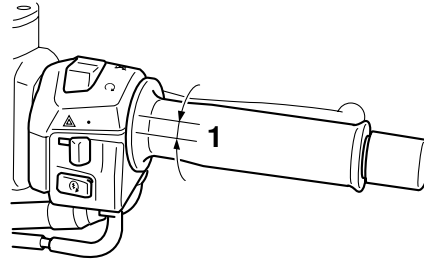

1. Throttle cable free play

The throttle cable free play should measure 3.0–5.0 mm (0.12–0.20 in) at the throttle grip. Periodically check the throttle cable free play and, if necessary, have a Yamaha dealer adjust it.

Valve clearance

The valve clearance changes with use, resulting in improper air-fuel mixture and/or engine noise. To prevent this from occurring, the valve clearance must be adjusted by a Yamaha dealer at the intervals specified in the periodic maintenance and lubrication chart.

PERIODIC MAINTENANCE AND ADJUSTMENT

Tires

EAU33601

To maximize the performance, durability, and safe operation of your vehicle, note the following points regarding the specified tires.

Tire air pressure

The tire air pressure should be checked and, if necessary, adjusted before each ride.

EWA10501



WARNING

Operation of this vehicle with improper tire pressure may cause severe injury or death from loss of control.

- The tire air pressure must be checked and adjusted on cold tires (i.e., when the temperature of the tires equals the ambient temperature).
- The tire air pressure must be adjusted in accordance with the riding speed and with the total weight of rider, passenger, cargo, and accessories approved for this model.

Tire air pressure (measured on cold tires):

0–90 kg (0–198 lb):

Front:

225 kPa (2.25 kgf/cm², 33 psi)

Rear:

250 kPa (2.50 kgf/cm², 36 psi)

XP500 90–194 kg (198–428 lb)

XP500A 90–190 kg (198–419 lb):

Front:

225 kPa (2.25 kgf/cm², 33 psi)

Rear:

280 kPa (2.80 kgf/cm², 41 psi)

Maximum load*:

XP500 194 kg (428 lb)

XP500A 190 kg (419 lb)

* Total weight of rider, passenger, cargo and accessories

EWA10511



WARNING

Never overload your vehicle. Operation of an overloaded vehicle could cause an accident.

Tire inspection

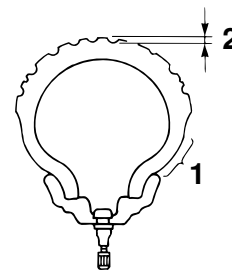

1. Tire sidewall
2. Tire tread depth

The tires must be checked before each ride. If the center tread depth reaches the specified limit, if the tire has a nail or glass fragments in it, or if the sidewall is cracked, have a Yamaha dealer replace the tire immediately.

Minimum tire tread depth (front and rear):

1.6 mm (0.06 in)

TIP

The tire tread depth limits may differ from country to country. Always comply with the local regulations.

PERIODIC MAINTENANCE AND ADJUSTMENT

EAU21960

Tire information

This model is equipped with tubeless tires.

After extensive tests, only the tires listed below have been approved for this model by Yamaha Motor Co., Ltd.

Front tire:

Size:

120/70R15 M/C 56H

Manufacturer/model:

DUNLOP/GPR-100F

BRIDGESTONE/BT011F

Rear tire:

Size:

160/60R15 M/C 67H

Manufacturer/model:

DUNLOP/GPR-100L

BRIDGESTONE/BT012R

EWA10470

WARNING

- **Have a Yamaha dealer replace excessively worn tires. Besides being illegal, operating the vehicle with excessively worn tires decreases riding stability and can lead to loss of control.**
- **The replacement of all wheel and brake related parts, including the tires, should be left to a**

Yamaha dealer, who has the necessary professional knowledge and experience.

Cast wheels

To maximize the performance, durability, and safe operation of your vehicle, note the following points regarding the specified wheels.

- The wheel rims should be checked for cracks, bends or warpage before each ride. If any damage is found, have a Yamaha dealer replace the wheel. Do not attempt even the smallest repair to the wheel. A deformed or cracked wheel must be replaced.
- The wheel should be balanced whenever either the tire or wheel has been changed or replaced. An unbalanced wheel can result in poor performance, adverse handling characteristics, and a shortened tire life.
- Ride at moderate speeds after changing a tire since the tire surface must first be “broken in” for it to develop its optimal characteristics.

PERIODIC MAINTENANCE AND ADJUSTMENT

Front and rear brake lever free play

EAU33453

Front

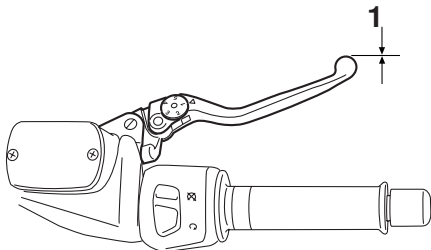

1. Front brake lever free play

Rear

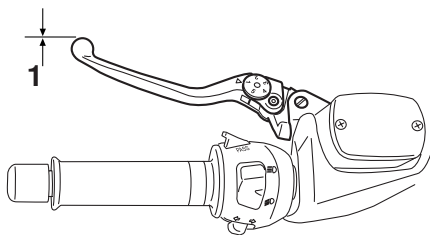

1. Rear brake lever free play

There should be no free play at the brake lever ends. If there is free play, have a Yamaha dealer inspect the brake system.



EWA14211

A soft or spongy feeling in the brake lever can indicate the presence of air in the hydraulic system. If there is air in the hydraulic system, have a Yamaha dealer bleed the system before operating the vehicle. Air in the hydraulic system will diminish the braking performance, which may result in loss of control and an accident.

Adjusting the rear brake lock lever cable

EAU33473

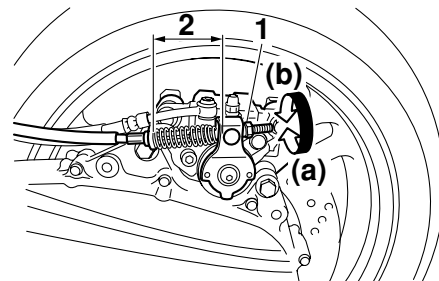

1. Adjusting nut
2. Rear brake lock lever cable length

Rear brake lock lever cable adjustment may be required if the rear brake lock lever does not hold properly. When the rear brake lock lever is not in use, the rear brake lock lever cable length should measure 45 mm to 47 mm (1.77 in to 1.85 in) at the rear brake caliper. Periodically check the rear brake lock lever cable length and, if necessary, adjust it as follows.

To increase the rear brake lock lever cable length, turn the adjusting nut at the rear brake caliper in direction (a).

PERIODIC MAINTENANCE AND ADJUSTMENT

To decrease the rear brake lock lever cable length, turn the adjusting nut in direction (b).

EWA10650



WARNING

If proper adjustment cannot be obtained as described, have a Yamaha dealer make this adjustment.

Checking the front and rear brake pads

EAU22390

The front and rear brake pads must be checked for wear at the intervals specified in the periodic maintenance and lubrication chart.

Front brake pads

EAU22410

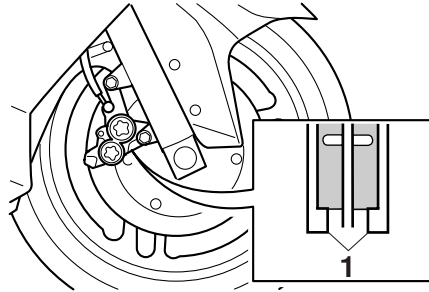

1. Wear indicator

Each front brake pad is provided with a wear indicator, which allows you to check the brake pad wear without having to disassemble the brake. To check the brake pad wear, check the position of the wear indicator while applying the brake. If a brake pad has worn to the

point that the wear indicator almost touches the brake disc, have a Yamaha dealer replace the brake pads as a set.

EAU22493

Rear brake pads

1. Remove the rear brake caliper by removing the bolts.

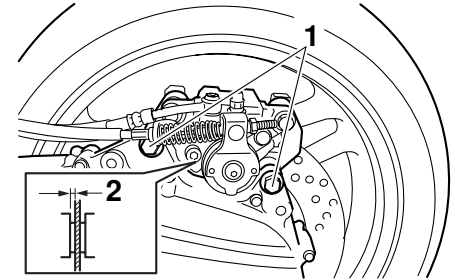

1. Brake caliper bolt
2. Lining thickness

2. Check each rear brake pad for damage and measure the lining thickness. If a brake pad is damaged or if the lining thickness is less than 0.8 mm (0.03 in), have a Yamaha dealer replace the brake pads as a set.
3. Install the rear brake caliper by in-

PERIODIC MAINTENANCE AND ADJUSTMENT

stalling the bolts, then tightening them to the specified torque.

Tightening torque:

Brake caliper bolt:
40 Nm (4.0 m·kgf, 28.9 ft·lbf)

ECA12822

NOTICE

Do not apply the rear brake or rear brake lock after the brake caliper has been removed, otherwise the brake caliper piston will be forced out.

EAU40260

Checking the brake fluid level

Front brake

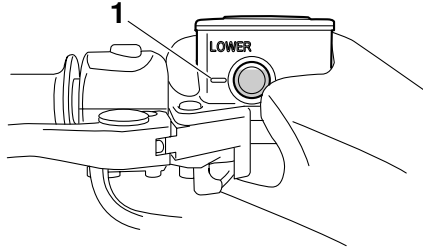

1. Minimum level mark

Rear brake

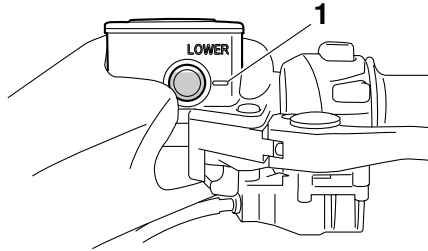

1. Minimum level mark

Insufficient brake fluid may allow air to

enter the brake system, possibly causing it to become ineffective.

Before riding, check that the brake fluid is above the minimum level mark and replenish if necessary. A low brake fluid level may indicate worn brake pads and/or brake system leakage. If the brake fluid level is low, be sure to check the brake pads for wear and the brake system for leakage.

Observe these precautions:

- When checking the fluid level, make sure that the top of the brake fluid reservoir is level.
- Use only the recommended quality brake fluid, otherwise the rubber seals may deteriorate, causing leakage and poor braking performance.

Recommended brake fluid:

DOT 4

- Refill with the same type of brake fluid. Mixing fluids may result in a harmful chemical reaction and lead to poor braking performance.
- Be careful that water or dust does not enter the brake fluid reservoir

PERIODIC MAINTENANCE AND ADJUSTMENT

when refilling. Water will significantly lower the boiling point of the fluid and may result in vapor lock, and dirt may clog the ABS hydraulic unit valves.

- Brake fluid may deteriorate painted surfaces or plastic parts. Always clean up spilled fluid immediately.
- As the brake pads wear, it is normal for the brake fluid level to gradually go down. However, if the brake fluid level goes down suddenly, have a Yamaha dealer check the cause.

EAU22731

Changing the brake fluid

Have a Yamaha dealer change the brake fluid at the intervals specified in the TIP after the periodic maintenance and lubrication chart. In addition, have the oil seals of the master cylinders and calipers as well as the brake hoses replaced at the intervals listed below or whenever they are damaged or leaking.

- Oil seals: Replace every two years.
- Brake hoses: Replace every four years.

EAU23111

Checking and lubricating the throttle grip and cable

The operation of the throttle grip should be checked before each ride. In addition, the cable should be lubricated at the intervals specified in the periodic maintenance chart.

PERIODIC MAINTENANCE AND ADJUSTMENT

Lubricating the front and rear brake levers

EAU23172

tenance and lubrication chart.

Recommended lubricant:
Silicone grease

Front brake lever

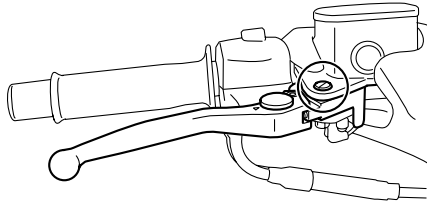

Rear brake lever

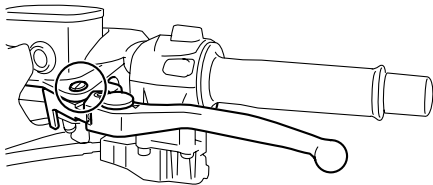

The pivoting points of the front and rear brake levers must be lubricated at the intervals specified in the periodic main-

Checking and lubricating the centerstand and sidestand

EAU23213

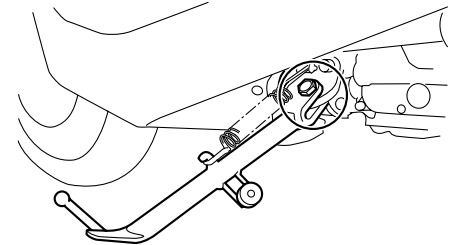
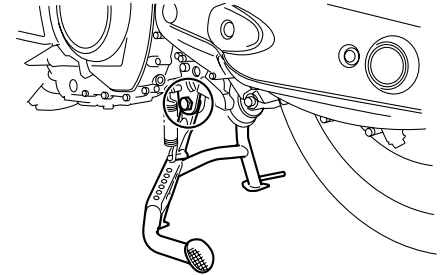

The operation of the centerstand and sidestand should be checked before each ride, and the pivots and metal-to-metal contact surfaces should be lubricated if necessary.

PERIODIC MAINTENANCE AND ADJUSTMENT

EWA10741

EAU23272

WARNING

If the centerstand or sidestand does not move up and down smoothly, have a Yamaha dealer check or repair it. Otherwise, the centerstand or sidestand could contact the ground and distract the operator, resulting in a possible loss of control.

Recommended lubricant:
Lithium-soap-based grease

Checking the front fork

The condition and operation of the front fork must be checked as follows at the intervals specified in the periodic maintenance and lubrication chart.

To check the condition

Check the inner tubes for scratches, damage and excessive oil leakage.

To check the operation

1. Place the vehicle on a level surface and hold it in an upright position. **WARNING! To avoid injury, securely support the vehicle so there is no danger of it falling over.**^[EWA10751]
2. While applying the front brake, push down hard on the handlebars several times to check if the front fork compresses and rebounds smoothly.

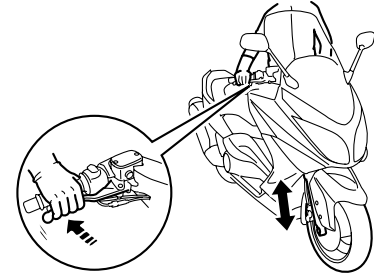

ECA10590

NOTICE

If any damage is found or the front fork does not operate smoothly, have a Yamaha dealer check or repair it.

PERIODIC MAINTENANCE AND ADJUSTMENT

EAU45511

Checking the steering

Worn or loose steering bearings may cause danger. Therefore, the operation of the steering must be checked as follows at the intervals specified in the periodic maintenance and lubrication chart.

1. Place the vehicle on the center-stand. **WARNING! To avoid injury, securely support the vehicle so there is no danger of it falling over.**^[EWA10751]
2. Hold the lower ends of the front fork legs and try to move them forward and backward. If any free play can be felt, have a Yamaha dealer check or repair the steering.

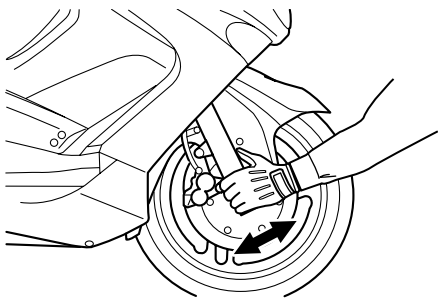

EAU23290

Checking the wheel bearings

The front and rear wheel bearings must be checked at the intervals specified in the periodic maintenance and lubrication chart. If there is play in the wheel hub or if the wheel does not turn smoothly, have a Yamaha dealer check the wheel bearings.

EAU45033

Battery

The battery is located under panel B. (See page 6-7.)

This model is equipped with a VRLA (Valve Regulated Lead Acid) battery. There is no need to check the electrolyte or to add distilled water. However, the battery lead connections need to be checked and, if necessary, tightened.

EWA10760

WARNING

- **Electrolyte is poisonous and dangerous since it contains sulfuric acid, which causes severe burns. Avoid any contact with skin, eyes or clothing and always shield your eyes when working near batteries. In case of contact, administer the following FIRST AID.**
 - **EXTERNAL:** Flush with plenty of water.
 - **INTERNAL:** Drink large quantities of water or milk and immediately call a physician.
 - **EYES:** Flush with water for 15 minutes and seek prompt

PERIODIC MAINTENANCE AND ADJUSTMENT

medical attention.

- Batteries produce explosive hydrogen gas. Therefore, keep sparks, flames, cigarettes, etc., away from the battery and provide sufficient ventilation when charging it in an enclosed space.
- **KEEP THIS AND ALL BATTERIES OUT OF THE REACH OF CHILDREN.**

To access the battery

1. Remove panel B. (See page 6-7.)
2. Remove the rubber cover shown by removing the quick fasteners.

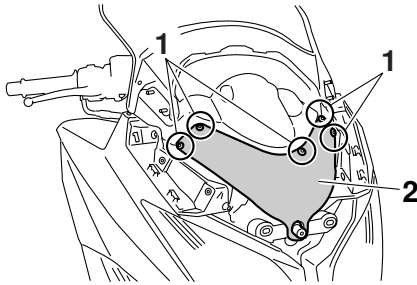

1. Quick fastener
2. Rubber cover

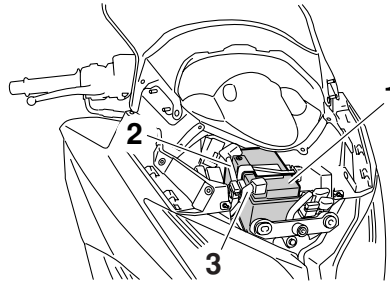

1. Battery
2. Positive battery lead
3. Negative battery lead

To charge the battery

Have a Yamaha dealer charge the battery as soon as possible if it seems to have discharged. Keep in mind that the battery tends to discharge more quickly if the vehicle is equipped with optional electrical accessories.

ECA16520

NOTICE

To charge a VRLA (Valve Regulated Lead Acid) battery, a special (constant-voltage) battery charger is required. Using a conventional battery charger will damage the battery. If you do not have access to a con-

stant-voltage battery charger, have a Yamaha dealer charge your battery.

To store the battery

1. If the vehicle will not be used for more than one month, remove the battery, fully charge it, and then place it in a cool, dry place. **NOTICE:** When removing the battery, be sure the key is turned to “OFF”, then disconnect the negative lead before disconnecting the positive lead.^[ECA16302]
2. If the battery will be stored for more than two months, check it at least once a month and fully charge it if necessary.
3. Fully charge the battery before installation.
4. After installation, make sure that the battery leads are properly connected to the battery terminals.

ECA16530

NOTICE

Always keep the battery charged. Storing a discharged battery can cause permanent battery damage.

PERIODIC MAINTENANCE AND ADJUSTMENT

EAU46310

Replacing the fuses

The main fuse and the fuse box, which contains the fuses for the individual circuits, are located under panel B. (See page 6-7.)

1. Remove panel B. (See page 6-7.)
2. Remove the rubber cover shown by removing the quick fasteners.

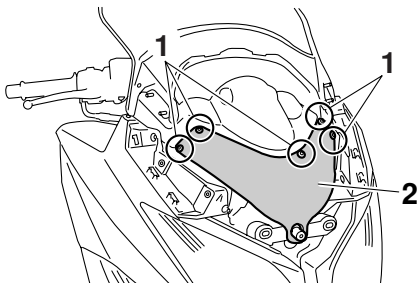

1. Quick fastener
2. Rubber cover

If a fuse is blown, replace it as follows.

1. Turn the key to "OFF" and turn off the electrical circuit in question.
2. Remove the blown fuse, and then install a new fuse of the specified amperage. **WARNING! Do not use a fuse of a higher amperage**

rating than recommended to avoid causing extensive damage to the electrical system and possibly a fire.^[EWA15131]

For XP500

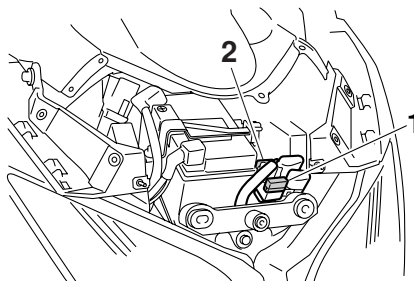

1. Main fuse
2. Spare main fuse

For XP500A

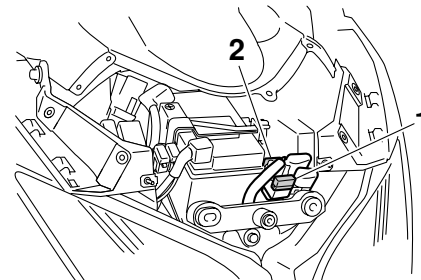

1. Main fuse
2. Spare main fuse

For XP500

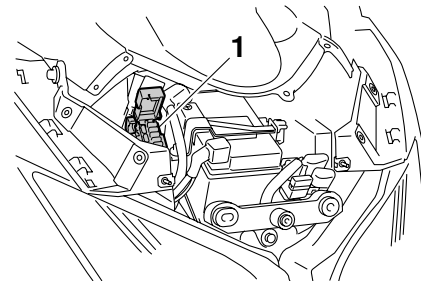

1. Fuse box

PERIODIC MAINTENANCE AND ADJUSTMENT

For XP500A

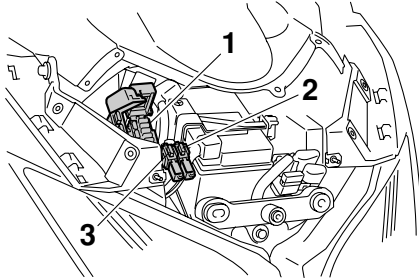

1. Fuse box
2. ABS solenoid fuse
3. ABS motor fuse

For XP500

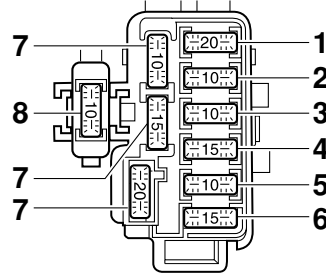

1. Headlight fuse
2. Ignition fuse
3. Backup fuse (for odometer and clock)
4. Radiator fan fuse
5. Fuel injection system fuse
6. Signaling system fuse
7. Spare fuse
8. Parking lighting fuse

For XP500A

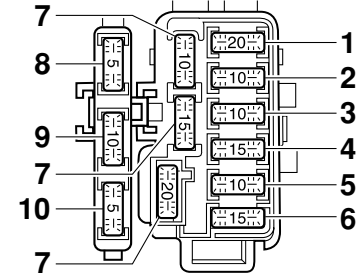

1. Headlight fuse
2. Ignition fuse
3. Backup fuse (for odometer and clock)
4. Radiator fan fuse
5. Fuel injection system fuse
6. Signaling system fuse
7. Spare fuse
8. ABS control unit fuse
9. Parking lighting fuse
10. Spare fuse

PERIODIC MAINTENANCE AND ADJUSTMENT

Specified fuses:

- Main fuse:
30.0 A
- Headlight fuse:
20.0 A
- Signaling system fuse:
15.0 A
- Ignition fuse:
10.0 A
- Parking lighting fuse:
10.0 A
- Radiator fan fuse:
15.0 A
- Fuel injection system fuse:
10.0 A
- ABS control unit fuse:
XP500A 5.0 A
- ABS motor fuse:
XP500A 30.0 A
- ABS solenoid fuse:
XP500A 20.0 A
- Backup fuse:
10.0 A

3. Turn the key to "ON" and turn on the electrical circuit in question to check if the device operates.
4. If the fuse immediately blows again, have a Yamaha dealer check the electrical system.

Replacing the headlight bulb

This model is equipped with a quartz bulb headlight. If the headlight bulb burns out, replace it as follows.

NOTICE

Do not touch the glass part of the headlight bulb to keep it free from oil, otherwise the transparency of the glass, the luminosity of the bulb, and the bulb life will be adversely affected. Thoroughly clean off any dirt and fingerprints on the headlight bulb using a cloth moistened with alcohol or thinner.

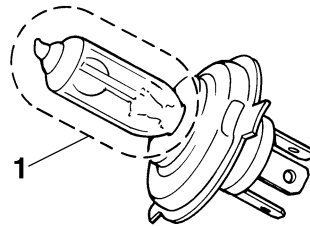

1. Do not touch the glass part of the bulb.

1. Disconnect the headlight coupler,

and then remove the headlight bulb cover.

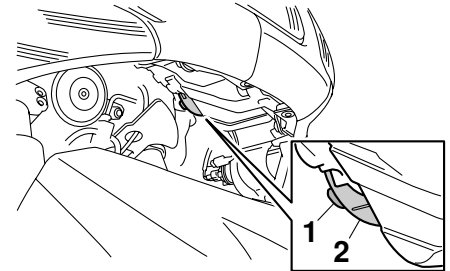

1. Headlight coupler
2. Bulb cover

2. Unhook the headlight bulb holder, and then remove the burnt-out bulb.

PERIODIC MAINTENANCE AND ADJUSTMENT

EAU43040

EAU43051

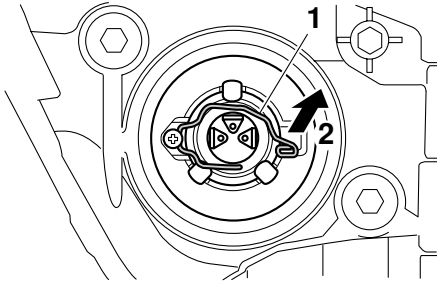

Tail/brake light

If the tail/brake light does not come on, have a Yamaha dealer check its electrical circuit or replace the bulb.

1. Headlight bulb holder
2. Unhook.
3. Place a new headlight bulb into position, and then secure it with the bulb holder.
4. Install the headlight bulb cover, and then connect the coupler.
5. Have a Yamaha dealer adjust the headlight beam if necessary.

Replacing a front turn signal light bulb

1. Place the scooter on the center-stand.
2. Remove the socket (together with the bulb) by turning it counter-clockwise.

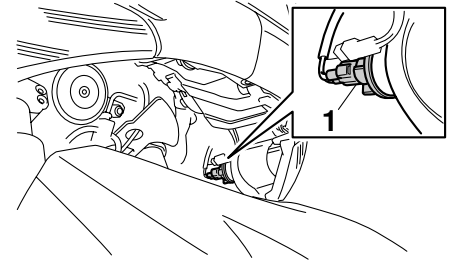

1. Turn signal light bulb socket
3. Remove the burnt-out bulb by pulling it out.
4. Insert a new bulb into the socket.
5. Install the socket (together with the bulb) by turning it clockwise.

PERIODIC MAINTENANCE AND ADJUSTMENT

EAUT1330

Rear turn signal light bulb

If a rear turn signal light does not come on, have a Yamaha dealer check the electrical circuit or replace the bulb.

EAU24312

Replacing the license plate light bulb

1. Remove the license plate light unit by removing the screws.

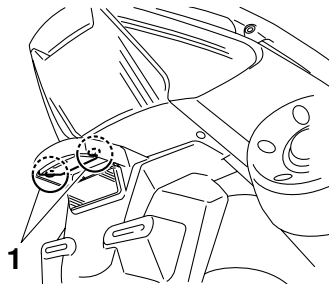

1. Screw
2. Remove the socket (together with the bulb) by pulling it out.

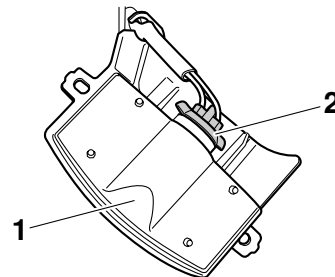

1. License plate light unit
2. License plate light bulb socket
3. Remove the burnt-out bulb by pulling it out.
4. Insert a new bulb into the socket.
5. Install the socket (together with the bulb) by pushing it in.
6. Install the license plate light unit by installing the screws.

EAU43231

Replacing an auxiliary light bulb

This model is equipped with two auxiliary lights. If an auxiliary light bulb burns out, replace it as follows.

1. Remove the socket (together with the bulb) by pulling it out.

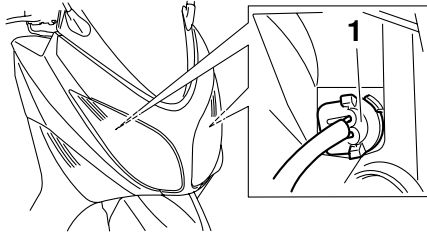

1. Auxiliary light bulb socket
2. Remove the burnt out bulb by pulling it out.
3. Insert a new bulb into the socket.
4. Install the socket (together with the bulb) by pushing it in.

EAU25881

Troubleshooting

Although Yamaha scooters receive a thorough inspection before shipment from the factory, trouble may occur during operation. Any problem in the fuel, compression, or ignition systems, for example, can cause poor starting and loss of power.

The following troubleshooting charts represent quick and easy procedures for checking these vital systems yourself. However, should your scooter require any repair, take it to a Yamaha dealer, whose skilled technicians have the necessary tools, experience, and know-how to service the scooter properly.

Use only genuine Yamaha replacement parts. Imitation parts may look like Yamaha parts, but they are often inferior, have a shorter service life and can lead to expensive repair bills.

EWA15141

WARNING

When checking the fuel system, do not smoke, and make sure there are no open flames or sparks in the area, including pilot lights from water

heaters or furnaces. Gasoline or gasoline vapors can ignite or explode, causing severe injury or property damage.

PERIODIC MAINTENANCE AND ADJUSTMENT

EAU42501

Troubleshooting charts

Starting problems or poor engine performance

1. Fuel

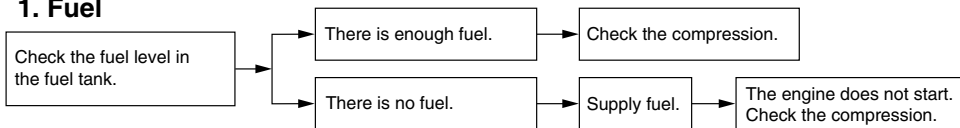

2. Compression

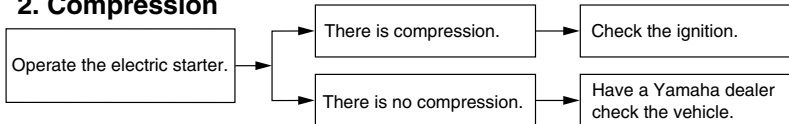

3. Ignition

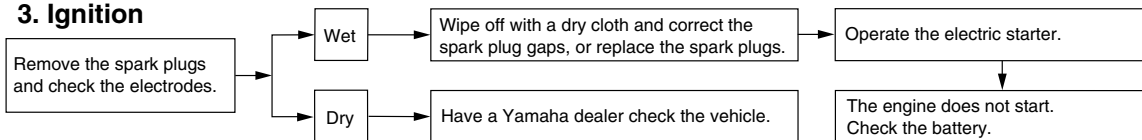

4. Battery

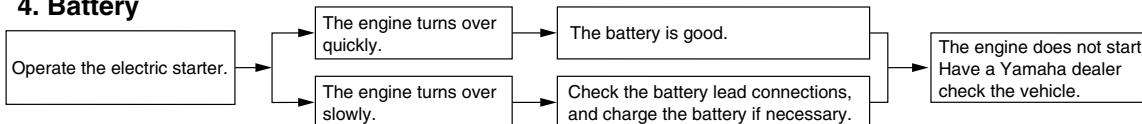

6

PERIODIC MAINTENANCE AND ADJUSTMENT

Engine overheating

EWAT1040

WARNING

- Do not remove the radiator cap when the engine and radiator are hot. Scalding hot fluid and steam may be blown out under pressure, which could cause serious injury. Be sure to wait until the engine has cooled.
- Place a thick rag, like a towel, over the radiator cap, and then slowly rotate the cap counterclockwise to the detent to allow any residual pressure to escape. When the hissing sound has stopped, press down on the cap while turning it counterclockwise, and then remove the cap.

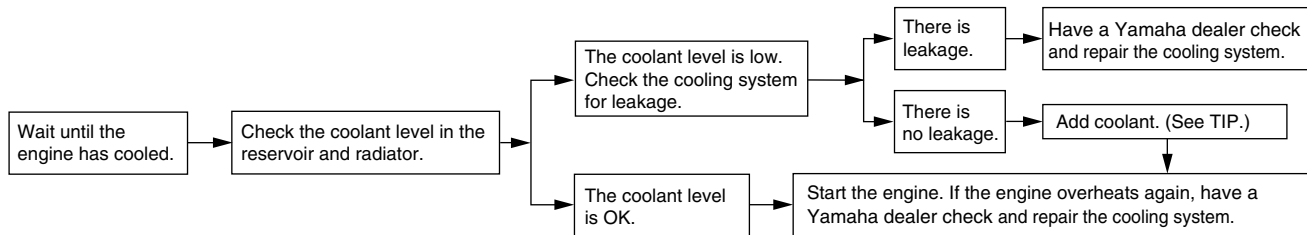

TIP

If coolant is not available, tap water can be temporarily used instead, provided that it is changed to the recommended coolant as soon as possible.

SCOOTER CARE AND STORAGE

Matte color caution

EAU37833

EAU26103

NOTICE

Some models are equipped with matte colored finished parts. Be sure to consult a Yamaha dealer for advice on what products to use before cleaning the vehicle. Using a brush, harsh chemical products or cleaning compounds when cleaning these parts will scratch or damage their surface. Wax also should not be applied to any matte colored finished parts.

ECA15192

Care

While the open design of a scooter reveals the attractiveness of the technology, it also makes it more vulnerable. Rust and corrosion can develop even if high-quality components are used. A rusty exhaust pipe may go unnoticed on a car, however, it detracts from the overall appearance of a scooter. Frequent and proper care does not only comply with the terms of the warranty, but it will also keep your scooter looking good, extend its life and optimize its performance.

Before cleaning

1. Cover the muffler outlet with a plastic bag after the engine has cooled down.
2. Make sure that all caps and covers as well as all electrical couplers and connectors, including the spark plug cap, are tightly installed.
3. Remove extremely stubborn dirt, like oil burnt onto the crankcase, with a degreasing agent and a brush, but never apply such prod-

ucts onto seals, gaskets and wheel axles. Always rinse the dirt and degreaser off with water.

Cleaning

ECA10782

NOTICE

- **Avoid using strong acidic wheel cleaners, especially on spoked wheels. If such products are used on hard-to-remove dirt, do not leave the cleaner on the affected area any longer than instructed. Also, thoroughly rinse the area off with water, immediately dry it, and then apply a corrosion protection spray.**
- **Improper cleaning can damage plastic parts (such as cowlings, panels, windshields, headlight lenses, meter lenses, etc.) and the mufflers. Use only a soft, clean cloth or sponge with water to clean plastic. However, if the plastic parts cannot be thoroughly cleaned with water, diluted mild detergent with water may be used. Be sure to rinse off any detergent residue using**

SCOOTER CARE AND STORAGE

plenty of water, as it is harmful to plastic parts.

- Do not use any harsh chemical products on plastic parts. Be sure to avoid using cloths or sponges which have been in contact with strong or abrasive cleaning products, solvent or thinner, fuel (gasoline), rust removers or inhibitors, brake fluid, antifreeze or electrolyte.
- Do not use high-pressure washers or steam-jet cleaners since they cause water seepage and deterioration in the following areas: seals (of wheel and swing-arm bearings, fork and brakes), electric components (couplers, connectors, instruments, switches and lights), breather hoses and vents.
- For scooters equipped with a windshield: Do not use strong cleaners or hard sponges as they will cause dulling or scratching. Some cleaning compounds for plastic may leave scratches on the windshield.

Test the product on a small hidden part of the windshield to make sure that it does not leave any marks. If the windshield is scratched, use a quality plastic polishing compound after washing.

After normal use

Remove dirt with warm water, a mild detergent, and a soft, clean sponge, and then rinse thoroughly with clean water. Use a toothbrush or bottlebrush for hard-to-reach areas. Stubborn dirt and insects will come off more easily if the area is covered with a wet cloth for a few minutes before cleaning.

After riding in the rain, near the sea or on salt-sprayed roads

Since sea salt or salt sprayed on roads during winter are extremely corrosive in combination with water, carry out the following steps after each ride in the rain, near the sea or on salt-sprayed roads.

TIP

Salt sprayed on roads in the winter may

remain well into spring.

1. Clean the scooter with cold water and a mild detergent after the engine has cooled down. **NOTICE: Do not use warm water since it increases the corrosive action of the salt.**^[ECA10791]
2. Apply a corrosion protection spray on all metal, including chrome- and nickel-plated, surfaces to prevent corrosion.

After cleaning

1. Dry the scooter with a chamois or an absorbing cloth.
2. Use a chrome polish to shine chrome, aluminum and stainless-steel parts, including the exhaust system. (Even the thermally induced discoloring of stainless-steel exhaust systems can be removed through polishing.)
3. To prevent corrosion, it is recommended to apply a corrosion protection spray on all metal, including chrome- and nickel-plated, surfaces.
4. Use spray oil as a universal clean-

SCOOTER CARE AND STORAGE

EAU36551

- er to remove any remaining dirt.
5. Touch up minor paint damage caused by stones, etc.
 6. Wax all painted surfaces.
 7. Let the scooter dry completely before storing or covering it.

EWA10941

WARNING

Contaminants on the brakes or tires can cause loss of control.

- **Make sure that there is no oil or wax on the brakes or tires. If necessary, clean the brake discs and brake linings with a regular brake disc cleaner or acetone, and wash the tires with warm water and a mild detergent.**
- **Before operating the scooter test its braking performance and cornering behavior.**

ECA10800

NOTICE

- **Apply spray oil and wax sparingly and make sure to wipe off any excess.**
- **Never apply oil or wax to any rubber and plastic parts, but**

treat them with a suitable care product.

- **Avoid using abrasive polishing compounds as they will wear away the paint.**

TIP

- Consult a Yamaha dealer for advice on what products to use.
- Washing, rainy weather or humid climates can cause the headlight lens to fog. Turning the headlight on for a short period of time will help remove the moisture from the lens.

Storage

Short-term

Always store your scooter in a cool, dry place and, if necessary, protect it against dust with a porous cover.

ECA10820

NOTICE

- **Storing the scooter in a poorly ventilated room or covering it with a tarp, while it is still wet, will allow water and humidity to seep in and cause rust.**
- **To prevent corrosion, avoid damp cellars, stables (because of the presence of ammonia) and areas where strong chemicals are stored.**

Long-term

Before storing your scooter for several months:

1. Follow all the instructions in the “Care” section of this chapter.
2. Fill up the fuel tank and add fuel stabilizer (if available) to prevent the fuel tank from rusting and the

- fuel from deteriorating.
3. Perform the following steps to protect the cylinders, piston rings, etc. from corrosion.
 - a. Remove the spark plug caps and the spark plugs.
 - b. Pour a teaspoonful of engine oil into the spark plug bores.
 - c. Install the spark plug caps onto the spark plugs, and then place the spark plugs on the cylinder head so that the electrodes are grounded. (This will limit sparking during the next step.)
 - d. Turn the engine over several times with the starter. (This will coat the cylinder walls with oil.)
 - e. Remove the spark plug caps from the spark plugs, and then install the spark plugs and the spark plug caps. **WARNING! To prevent damage or injury from sparking, make sure to ground the spark plug electrodes while turning the engine over.**^[EWA10951]
 4. Lubricate all control cables and the pivoting points of all levers and pedals as well as of the sidestand/centerstand.
 5. Check and, if necessary, correct the tire air pressure, and then lift the scooter so that both of its wheels are off the ground. Alternatively, turn the wheels a little every month in order to prevent the tires from becoming degraded in one spot.
 6. Cover the muffler outlet with a plastic bag to prevent moisture from entering it.
 7. Remove the battery and fully charge it. Store it in a cool, dry place and charge it once a month. Do not store the battery in an excessively cold or warm place [less than 0 °C (30 °F) or more than 30 °C (90 °F)]. For more information on storing the battery, see page 6-27.

TIP

Make any necessary repairs before storing the scooter.

SPECIFICATIONS

EAU2633P

Dimensions:

Overall length:
2195 mm (86.4 in)
Overall width:
775 mm (30.5 in)
Overall height:
1445 mm (56.9 in)
Seat height:
800 mm (31.5 in)
Wheelbase:
1580 mm (62.2 in)
Ground clearance:
125 mm (4.92 in)
Minimum turning radius:
2800 mm (110.2 in)

Weight:

With oil and fuel:
XP500 221.0 kg (487 lb)
XP500A 225.0 kg (496 lb)

Engine:

Engine type:
Liquid cooled 4-stroke, DOHC
Cylinder arrangement:
Forward-inclined parallel 2-cylinder
Displacement:
499.0 cm³
Bore × stroke:
66.0 × 73.0 mm (2.60 × 2.87 in)
Compression ratio:
11.00 :1

Starting system:
Electric starter
Lubrication system:
Dry sump

Engine oil:

Type:
SAE 10W-30 or SAE 10W-40
Recommended engine oil grade:
API service SG type or higher, JASO standard MA

Engine oil quantity:

Without oil filter cartridge replacement:
2.80 L (2.96 US qt, 2.46 Imp.qt)
With oil filter cartridge replacement:
2.90 L (3.07 US qt, 2.55 Imp.qt)

Chain drive oil:

Type:
SAE 80 API GL-4 Hypoid gear oil
Quantity:
0.70 L (0.74 US qt, 0.62 Imp.qt)

Cooling system:

Coolant reservoir capacity (up to the maximum level mark):
0.25 L (0.26 US qt, 0.22 Imp.qt)
Radiator capacity (including all routes):
1.48 L (1.56 US qt, 1.30 Imp.qt)

Air filter:

Air filter element:
Oil-coated paper element

Fuel:

Recommended fuel:
Regular unleaded gasoline only

Fuel tank capacity:
15.0 L (3.96 US gal, 3.30 Imp.gal)
Fuel reserve amount:
3.0 L (0.79 US gal, 0.66 Imp.gal)

Fuel injection:

Throttle body:
Manufacturer:
MIKUNI
Type/quantity:
ACW31-10/1

Spark plug (s):

Manufacturer/model:
NGK/CR7E
Spark plug gap:
0.7–0.8 mm (0.028–0.031 in)

Clutch:

Clutch type:
Wet, multiple-disc automatic

Transmission:

Primary reduction system:
Spur gear/helical gear
Primary reduction ratio:
52/32 × 36/22 (2.659)
Secondary reduction system:
Chain drive
Secondary reduction ratio:
41/25 × 40/29 (2.262)
Transmission type:
V-belt automatic
Operation:
Centrifugal automatic type

Chassis:

Frame type:
Diamond
Caster angle:
25.00 °
Trail:
92.0 mm (3.62 in)

Front tire:

Type:
Tubeless
Size:
120/70R15 M/C 56H
Manufacturer/model:
DUNLOP/GPR-100F
Manufacturer/model:
BRIDGESTONE/BT011F

Rear tire:

Type:
Tubeless
Size:
160/60R15 M/C 67H
Manufacturer/model:
DUNLOP/GPR-100L
Manufacturer/model:
BRIDGESTONE/BT012R

Loading:

Maximum load:
XP500 194 kg (428 lb)
XP500A 190 kg (419 lb)
* (Total weight of rider, passenger, cargo
and accessories)

Tire air pressure (measured on cold tires):

Loading condition:
0–90 kg (0–198 lb)
Front:
225 kPa (2.25 kgf/cm², 33 psi)
Rear:
250 kPa (2.50 kgf/cm², 36 psi)
Loading condition:
XP500 90–194 kg (198–428 lb)
XP500A 90–190 kg (198–419 lb)
Front:
225 kPa (2.25 kgf/cm², 33 psi)
Rear:
280 kPa (2.80 kgf/cm², 41 psi)

Front wheel:

Wheel type:
Cast wheel
Rim size:
15M/C x MT3.50

Rear wheel:

Wheel type:
Cast wheel
Rim size:
15M/C x MT5.00

Front brake:

Type:
Dual disc brake
Operation:
Right hand operation
Recommended fluid:
DOT 4

Rear brake:

Type:
Single disc brake
Operation:
Left hand operation
Recommended fluid:
DOT 4

Front suspension:

Type:
Telescopic fork
Spring/shock absorber type:
Coil spring/oil damper
Wheel travel:
120.0 mm (4.72 in)

Rear suspension:

Type:
Swingarm
Spring/shock absorber type:
Coil spring/gas-oil damper
Wheel travel:
116.0 mm (4.57 in)

Electrical system:

Ignition system:
TCI (digital)
Charging system:
AC magneto

Battery:

Model:
YTZ10S
Voltage, capacity:
12 V, 8.6 Ah

SPECIFICATIONS

Headlight:

Bulb type:
Halogen bulb

Bulb voltage, wattage × quantity:

Headlight:
12 V, 60 W/55.0 W × 1

Headlight:
12 V, 55.0 W × 1

Tail/brake light:
12 V, 5.0 W/21.0 W × 1

Front turn signal light:
12 V, 21.0 W × 2

Rear turn signal light:
12 V, 21.0 W × 2

Auxiliary light:
12 V, 5.0 W × 2

License plate light:
12 V, 5.0 W × 1

Meter lighting:
LED

High beam indicator light:
LED

Turn signal indicator light:
LED x 2

Engine trouble warning light:
LED

ABS warning light:
XP500A LED

Immobilizer system indicator light:
LED

Fuses:

Main fuse:
30.0 A

Headlight fuse:

20.0 A

Signaling system fuse:

15.0 A

Ignition fuse:

10.0 A

Parking lighting fuse:

10.0 A

Radiator fan fuse:

15.0 A

Fuel injection system fuse:

10.0 A

ABS control unit fuse:

XP500A 5.0 A

ABS motor fuse:

XP500A 30.0 A

ABS solenoid fuse:

XP500A 20.0 A

Backup fuse:

10.0 A

EAU26351

Identification numbers

Record the key identification number, vehicle identification number and model label information in the spaces provided below for assistance when ordering spare parts from a Yamaha dealer or for reference in case the vehicle is stolen.

KEY IDENTIFICATION NUMBER:

VEHICLE IDENTIFICATION NUMBER:

MODEL LABEL INFORMATION:

EAU26381

Key identification number

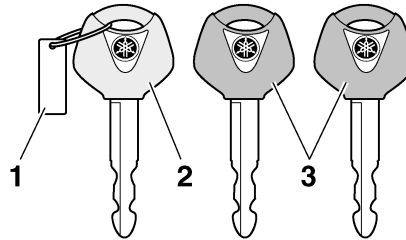

1. Key identification number
2. Code re-registering key (red bow)
3. Standard keys (black bow)

The key identification number is stamped into the key tag. Record this number in the space provided and use it for reference when ordering a new key.

EAU26410

Vehicle identification number

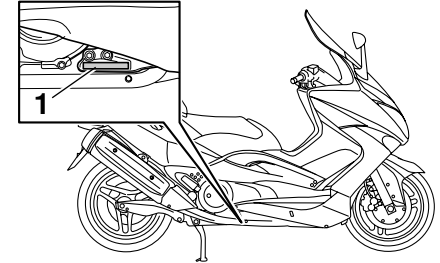

1. Vehicle identification number

The vehicle identification number is stamped into the frame.

TIP _____
The vehicle identification number is used to identify your vehicle and may be used to register it with the licensing authority in your area.

CONSUMER INFORMATION

EAU26500

Model label

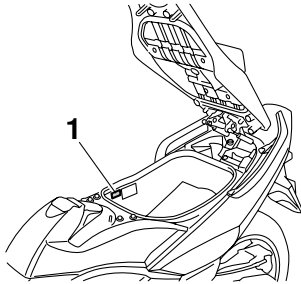

1. Model label

The model label is affixed to the inside of the rear storage compartment. (See page 3-20.) Record the information on this label in the space provided. This information will be needed when ordering spare parts from a Yamaha dealer.

- A**
- ABS (for ABS models)3-14
 - ABS warning light (for ABS models)3-3
 - Acceleration and deceleration5-2
 - Air filter element, replacing6-17
 - Anti-theft alarm (optional)3-11
 - Auxiliary light bulb, replacing6-34
- B**
- Battery6-27
 - Brake fluid, changing6-24
 - Brake fluid level, checking6-23
 - Brake lever, front3-12
 - Brake lever, rear3-13
 - Brake levers, lubricating6-25
 - Braking5-3
- C**
- Care7-1
 - Catalytic converter3-18
 - Centerstand and sidestand, checking and lubricating6-25
 - Chain drive oil6-14
 - Coolant6-15
 - Coolant temperature gauge3-5
- D**
- Dimmer switch3-11
- E**
- Engine break-in5-4
 - Engine idling speed6-17
 - Engine oil and oil filter cartridge6-11
 - Engine stop switch3-12
 - Engine trouble warning light3-3
- F**
- Front and rear brake lever free play6-21
 - Front and rear brake pads, checking6-22
 - Front fork, checking6-26
 - Fuel3-16
 - Fuel consumption, tips for reducing5-3
 - Fuel gauge3-5
 - Fuel tank cap3-15
 - Fuses, replacing6-29
- H**
- Handlebar switches3-11
 - Hazard switch3-12
 - Headlight bulb, replacing6-31
 - Helmet holder3-20
 - High beam indicator light3-3
 - Horn switch3-12
- I**
- Identification numbers9-1
 - Ignition circuit cut-off system3-23
 - Immobilizer system3-1
 - Immobilizer system indicator light3-4
 - Indicator and warning lights3-3
- K**
- Key identification number9-1
- L**
- License plate light bulb, replacing6-33
- M**
- Main switch/steering lock3-2
 - Matte color, caution7-1
 - Model label9-2
 - Multi-function display3-6
- P**
- Panels, removing and installing6-7
 - Parking5-4
 - Part locations2-1
 - Pass switch3-11
 - Periodic maintenance and lubrication chart6-3
- R**
- Rear brake lock lever3-14
 - Rear brake lock lever cable, adjusting6-21
 - Rear view mirrors3-22
 - Rider backrest, adjusting3-19
- S**
- Safe-riding points1-5
 - Safety information1-1
 - Seat3-18
 - Shock absorber assembly3-22
 - Sidestand3-23
 - Spark plugs, checking6-10
 - Specifications8-1
 - Speedometer3-4
 - Starting off5-2
 - Starting the engine5-1
 - Start switch3-12
 - Steering, checking6-27
 - Storage7-3
 - Storage compartments3-20
- T**
- Tail/brake light6-32
 - Throttle cable free play, checking6-18
 - Throttle grip and cable, checking and lubricating6-24
 - Tires6-19
 - Tool kit6-2
 - Troubleshooting6-34
 - Troubleshooting charts6-35
 - Turn signal indicator lights3-3
 - Turn signal light bulb (front), replacing6-32
 - Turn signal switch3-11

INDEX

V

- Valve clearance 6-18
- Vehicle identification number 9-1

W

- Wheel bearings, checking..... 6-27
- Wheels 6-20



YAMAHA MOTOR CO., LTD.

PRINTED ON RECYCLED PAPER

PRINTED IN JAPAN

2008.7-0.1x1 

(E)